



VIBRATEK

Applied Vibration Technology

PNEUMATIC VIBRATORS:

Lowest Air Consumption Longest Life Expectancy; Greatest Force & Frequency Control;
Lowest Maintenance; Highest Power to Weight Ratio

70 MODELS



vibratek.net

284 Three Tun Road Malvern, PA 19355-3981 • USA

Email: sales@vibratek.net Phone: 888.842.6977 Fax: 888.842.6966



WHO WE ARE.

Vibratek manufactures industrial quality vibrators, material flow, and material handling equipment for a variety of applications. Vibratek industrial vibrators are built to provide quiet, energy efficient, low maintenance, and safe operation.

C O N T E N T S



BALL VIBRATORS

Page 3



ROLLER VIBRATORS

Page 4

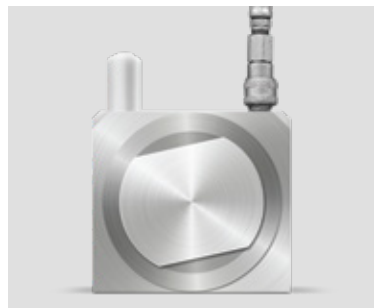

TURBINE VIBRATORS

Page 7



PISTON VIBRATORS

Page 9



BALL VIBRATORS

**BALL VIBRATORS, SIMPLE AND EFFICIENT.
WIDE RANGE FOR MANY APPLICATIONS.**



Properties

- Powerful
- Rated frequency 7'300 – 35'000 rpm
- Centrifugal force 29 – 911 lbf
- Continuously variable
- Can be used up to 212 °F
- HT version up to 302 °F on request
- Also available with ATEX certification

Field of application

- Emptying of bunkers
- Screen filters
- Vibrating tables
- Preventing adhesions in pipelines and silos
- Moving of goods

Construction

- Vibration by means of a ball that is guided by hardened steel guides.
- Nylon plates on both sides to support the ball and as protection from dust and water.
- Housing with 4 mounting bores, depending on the application.

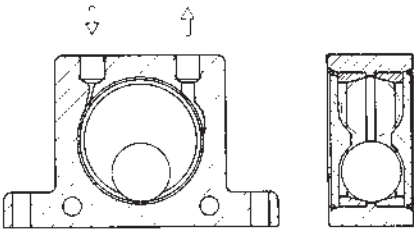

Housing made from extruded aluminum alloy
Hardened guides made of steel
Nylon end plates
Hardened ball

Model	Vibrations 1000 rpm			Centrifugal Force lbf			Consumption CF min ⁻¹		
	30 PSI	60 PSI	90 PSI	30 PSI	60 PSI	90 PSI	30 PSI	60 PSI	90 PSI
K-8	25.5	31.8	35	29	58	81	2.9	5.1	6.9
K-10	22.5	28	34	56	106	160	3.2	5.3	7.1
K-13	15	18.5	22.5	72	124	196	3.3	5.6	7.9
K-16	13	17	19.5	101	180	248	4.3	7.1	9.9
K-20	10.5	14.5	16.5	162	275	387	4.6	8.1	12
K-25	9.2	12.2	14	209	353	461	5.6	10.2	15
K-30	7.8	9.7	12.5	340	556	722	7.6	13.2	20
K-36	7.3	9	10	464	709	911	9.2	16.8	24

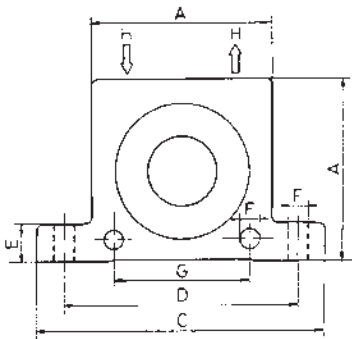

Model	A inches	Width inches	C inches	D inches	E inches	F inches	G inches	H Thread BSP	Weight lb
K-8	1.97	0.79	3.38	2.68	0.47	0.27	1.57	1/4"	0.29
K-10	1.97	0.79	3.38	2.68	0.47	0.27	1.57	1/4"	0.29
K-13	2.56	0.94	4.45	3.54	0.63	0.35	1.97	1/4"	0.57
K-16	2.56	1.06	4.45	3.54	0.63	0.35	1.97	1/4"	0.66
K-20	3.15	1.30	5.04	4.09	0.63	0.35	2.36	1/4"	1.17
K-25	3.15	1.50	5.04	4.09	0.63	0.35	2.36	1/4"	1.39
K-30	3.94	1.76	6.30	5.12	0.70	0.43	3.15	3/8"	2.49
K-36	3.94	1.97	6.30	5.12	0.79	0.43	3.15	3/8"	2.95

ROLLER VIBRATORS

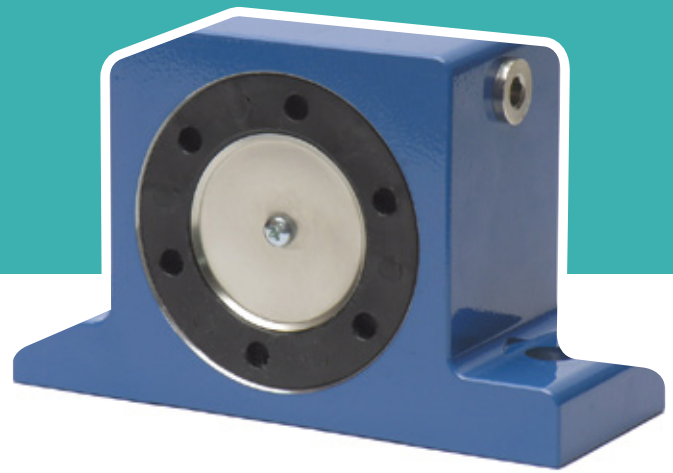

ROLLER VIBRATORS, SIMPLE AND EFFICIENT FOR A WIDE RANGE OF APPLICATIONS.

Properties

- High torque
- Rated frequency 10'000 – 36'000 rpm
- Centrifugal force 240 – 2'812 lbf
- Continuously variable
- Can be used up to 302 °F
- Resistant to extreme environmental conditions
- Also available with ATEX certification

Field of application

- Emptying of hoppers and chutes
- Screen filters
- Conveying of particulates
- Preventing adhesions in pipelines and silos
- Transporting of fine powders
- Compacting of plastic and concrete in troughs

Construction

- Vibration created by a rotating precision-steel roller
- Shockproof plastic end plates
- Housing with 4 mounting bores, depending on the application

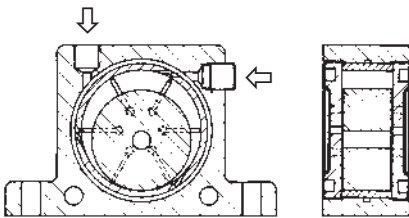

Housing made from extruded aluminum alloy
Cast iron strip
Steel roller
Plastic end plates

Model	Vibrations 1000 rpm			Centrifugal Force lbf			Consumption CF min ⁻¹		
	30 PSI	60 PSI	90 PSI	30 PSI	60 PSI	90 PSI	30 PSI	60 PSI	90 PSI
R-50	25.0	35.0	36.0	240	657	950	3.5	5.1	6.9
R-65	19.0	21.0	26.0	614	1089	1377	7.0	10.6	14.1
R-80	15.5	18.5	19.0	675	1370	1676	10.2	15.2	20.1
R-100	11.0	14.0	16.0	844	1519	2003	13.0	19.4	25.8
R-120	10.0	11.5	12.5	1800	2250	2812	17.6	25.8	34.2

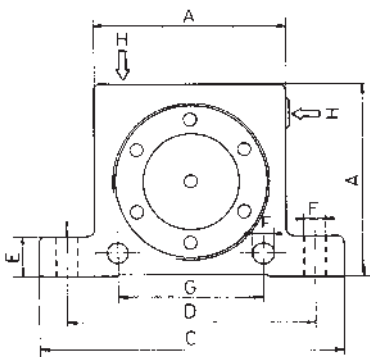

Model	A inches	Width inches	C inches	D inches	E inches	F inches	G inches	H Thread BSP	Weight lb
R-50	1.97	1.14	3.38	2.68	0.47	0.27	1.57	1/8"	0.53
R-65	2.56	1.46	4.45	3.54	0.63	0.35	1.97	1/4"	1.20
R-80	3.15	1.69	5.04	4.09	0.63	0.35	2.36	1/4"	2.10
R-100	3.94	2.05	6.3	5.12	0.76	0.43	3.15	3/8"	4.00
R-120	4.72	3.03	7.64	5.99	0.94	0.67	-	3/8"	9.40

ROLLER VIBRATORS DAR

ROLLER VIBRATORS FOR CONCRETE AND OTHER HEAVY-DUTY APPLICATIONS.



Properties

- High torque
- Rated frequency 7'800 – 38'000 rpm
- Centrifugal force 500 – 2'700 lbf
- Continuously variable
- Can be used up to 302 °F
- Resistant to extreme environmental conditions
- Also available with ATEX certification

Field of application

- Compacting of plastic and concrete
- Assisting the flow of material in silos and hoppers
- Separating of different sized products on sieves

Construction

- Vibration through rotating precision rollers in highly flexible steel guides
- Reinforced by two extra-shockproof bronze end plates

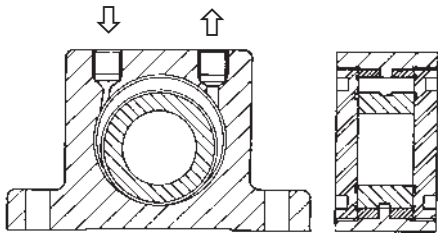

Housing made from extruded aluminum alloy
 Highly flexible steel guides
 Cast precision steel roller
 Special bronze end plates

Model	Vibrations 1000 rpm			Centrifugal Force lbf			Consumption CF min ⁻¹		
	30 PSI	60 PSI	90 PSI	30 PSI	60 PSI	90 PSI	30 PSI	60 PSI	90 PSI
DAR-2	36.0	38.0	38.0	500	760	920	2.5	4.9	7.0
DAR-3	27.0	32.0	32.0	612	1026	1361	3.5	7.0	10.6
DAR-4	18.0	22.5	25.0	531	1037	1505	4.2	8.8	12.7
DAR-5	9.5	15.0	16.5	378	1044	1620	4.6	9.5	13.8
DAR-6	7.8	10.0	12.0	983	1502	2317	6.0	11.3	16.6
DAR-7	8.0	9.8	11.5	1320	2137	2700	6.4	12.4	17.7

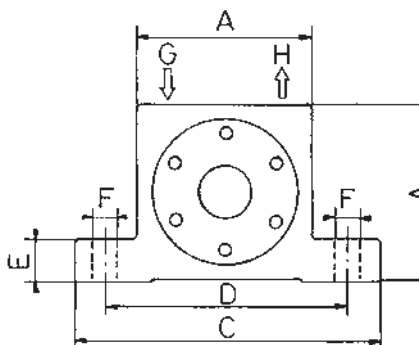

Model	A inches	Width inches	C inches	D inches	E inches	F inches	G/H Thread BSP	Weight lb
DAR-2	1.97	1.18	3.38	2.68	0.47	0.27	1/8"	0.82
DAR-3	2.56	1.42	4.45	3.54	0.63	0.35	1/4"	1.68
DAR-4	3.15	1.57	5.04	4.00	0.63	0.43	1/4"	2.80
DAR-5	3.94	2.05	6.30	5.12	0.79	0.51	3/8"	5.40
DAR-6	4.72	2.44	7.64	6.00	0.94	0.67	3/8"	10.35
DAR-7	4.72	3.03	7.64	6.00	0.94	0.67	3/8"	12.55

TURBINE VIBRATORS T

HIGH SPEED AND HIGH WORKING TORQUE FOR STRONG VIBRATION AT LARGE AMPLITUDE.



Properties

- Rated frequency 6'500 – 23'000 rpm
- Centrifugal force 135 – 1'364 lbf
- Continuously variable
- Can be used up to 212 °F
- Resistant to extreme environmental conditions
- Also available with ATEX certification

Field of application

- Emptying of bunkers
- Screen filters
- Vibrating tables
- Preventing adhesions in pipelines and silos
- Transporting of fine powders
- Moving of bulk materials

Construction

- Vibration with a high eccentric torque, caused by the rotor's imbalance
- Low noise level

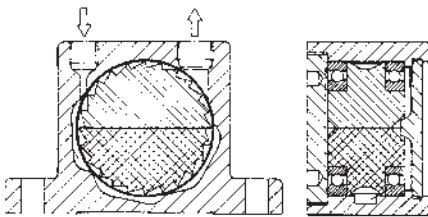

Housing made from extruded aluminum alloy with hard anodization

Ball bearing

Plastic end cap with screw thread

Nylon end cap

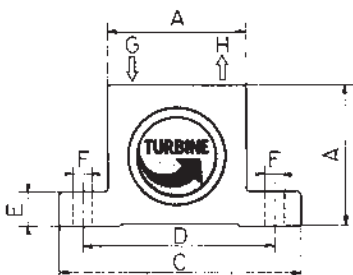

Model	Vibrations 1000 rpm			Centrifugal Force lbf			Consumption CF min ⁻¹		
	30 PSI	60 PSI	90 PSI	30 PSI	60 PSI	90 PSI	30 PSI	60 PSI	90 PSI
T-50/LP	17.0	21.5	23.0	157	279	385	2.4	4.0	5.8
T-50-HP	11.0	14.5	16.5	135	230	304	2.8	4.9	7.0
T-65-LP	9.5	13.0	15.0	173	310	405	3.1	5.5	8.3
T-65-HP	8.5	10.5	12.0	293	461	585	3.8	6.8	10.2
T-80/LP	9.0	11.5	13.0	414	666	853	5.3	9.2	13.6
T-80-HP	6.8	9.0	10.5	450	780	1066	-	9.2	13.6
T-100/HP	6.5	9.0	10.0	558	1080	1364	-	10.6	15.2

Model	A inches	Width inches	C inches	D inches	E inches	F inches	G Thread BSP	H Thread BSP	Weight lb
T-50/LP	1.97	1.81	3.38	2.68	0.47	0.27	1/8"	1/4"	0.86
T-50-HP	1.97	2.36	3.38	2.68	0.47	0.27	1/8"	1/4"	1.15
T-65-LP	2.56	1.97	4.45	3.54	0.63	0.35	1/4"	1/4"	1.60
T-65-HP	2.56	2.52	4.45	3.54	0.63	0.35	1/4"	1/4"	2.15
T-80/LP	3.15	2.20	5.04	4.09	0.63	0.43	1/4"	3/8"	2.70
T-80-HP	3.15	2.75	5.04	4.09	0.63	0.43	1/4"	3/8"	3.45
T-100/HP	3.94	2.64	6.30	5.12	0.70	0.51	3/8"	3/8"	5.00

GOLDEN TURBINE® GT VIBRATORS



HIGH SPEED AND ECCENTRIC WORKING TORQUES FOR STRONG VIBRATION.

Properties

- Lubrication-free
- Low noise level
- Strong vibration by means of high speed and eccentric working torques
- Rated frequency 6'000 – 46'000 rpm
- Centrifugal force 29 – 2'700 lbf
- Can be used up to 302 °F
- Resistant to extreme environmental conditions
- Also available with ATEX certification

Field of application

- Emptying of bunkers
- Screen filters
- Vibrating tables
- Preventing adhesions in pipelines and silos
- Transporting of fine powders
- Moving of bulk materials

Construction

- Vibration from the centrifugal force of positive and negative imbalanced torques in the rotor.
- Rotor on two pre-lubricated and enclosed ball bearings arranged in pairs. Lubricated with special grease for long life.

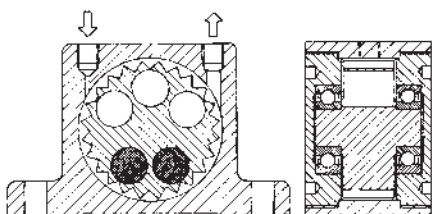

Housing made from extruded aluminum alloy
Turbine wheel made from surface-hardened aluminum
Surface-hardened aluminum end plates

Model	Vibrations 1000 rpm			Centrifugal Force lbf			Consumption CF min ⁻¹		
	30 PSI	60 PSI	90 PSI	30 PSI	60 PSI	90 PSI	30 PSI	60 PSI	90 PSI
GT-4	14.0	15.0	15.0	30	40	45	1.2	2.0	2.9
GT-6	11.5	12.0	12.5	29	39	47	1.2	2.0	2.9
GT-8	36.0	42.0	46.0	223	464	655	1.6	2.8	3.9
GT-10	27.5	35.0	37.5	189	313	540	1.6	2.8	3.9
GT-10-S	17.0	23.0	25.0	146	304	439	1.6	2.8	3.9
GT-13	26.0	30.0	33.0	315	549	839	4.2	7.0	10.2
GT-16	17.0	21.5	24.0	275	470	711	4.2	7.0	10.2
GT-16-S	11.5	15.5	17.0	248	428	608	4.2	7.0	10.2
GT-20	17.0	20.0	23.0	488	909	1242	6.5	11.4	16.0
GT-25	12.0	15.5	17	477	790	1140	6.5	11.4	16.0
GT-25-S	8.5	11.0	13.0	506	810	1102	6.5	11.4	16.0
GT-30	13.0	14.0	16.0	760	1222	1696	11.6	18.7	26.3
GT-36	8.0	10.0	13.0	740	1206	1618	11.6	18.7	26.3
GT-36-S	6.1	7.2	8.3	922	1395	1688	11.6	18.7	26.3
GT-40	7.7	8.8	9.5	968	1642	2205	15.0	24.7	34.2
GT-48	6.0	8.5	9.7	1102	1732	2363	15.0	24.7	34.2
GT-48-S	-	5.6	6.3	-	1688	2700	-	24.7	34.2

Model	A inches	Width inches	C inches	D inches	E inches	F inches	G/H Thread BSP	Weight lb
GT-4/6	1.58	1.10	2.76	2.21	0.41	0.24	1/8"	0.37
GT-8/10	1.97	1.30	3.38	2.68	0.47	0.27	1/8"	0.56
GT-13/16	2.56	1.65	4.45	3.54	0.68	0.35	1/4"	1.28
GT-20/25	3.15	2.20	5.04	4.09	0.68	0.35	1/4"	2.46
GT-30/36	3.94	2.87	6.30	5.12	0.79	0.43	3/8"	5.10
GT-40/48	4.72	3.26	7.64	5.99	0.94	0.67	3/8"	8.57

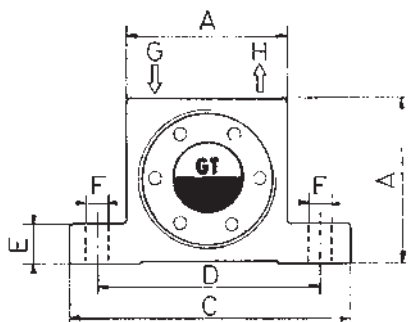

STAINLESS TURBINES GTRF



PNEUMATIC TURBINE VIBRATORS MADE OF STAINLESS-STEEL.

Properties

- Lubrication-free
- Low noise level
- Strong vibration by means of high speed and eccentric working torques
- Rated frequency 14'000 – 37'000 rpm
- Centrifugal force 169 – 1'284 lbf
- Continuously variable
- Can be used up to 302 °F
- Resistant to extreme environmental conditions
- Also available with ATEX certification

Field of application

- For foodstuffs and pharmaceuticals, complies with FDA specifications
- Emptying of bunkers
- Screen filter
- Vibrating tables
- Preventing adhesions in pipelines and silos
- Transporting of fine powders
- Moving of bulk materials

Construction

- Vibration from the centrifugal force of positive and negative imbalanced torques in the rotor.
- Rotor on two pre-lubricated and enclosed ball bearings arranged in pairs.
- Made from stainless-steel 316 and lubricated with special grease for long life.

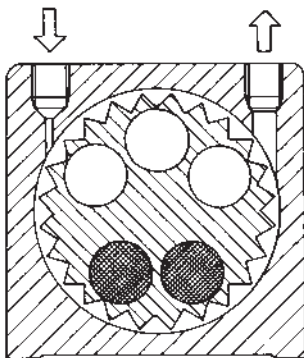

Housing made of stainless-steel

Turbine wheel made of surface-hardened aluminum

Model	Vibrations 1000 rpm			Centrifugal Force lbf			Consumption CF min ⁻¹		
	30 PSI	60 PSI	90 PSI	30 PSI	60 PSI	90 PSI	30 PSI	60 PSI	90 PSI
GT-10-RF	27.0	32.0	37.0	169	304	473	1.6	2.8	3.9
GT-16-RF	20.0	23.0	27.5	383	563	833	4.2	7.0	10.2
GT-25-RF	14.0	17.0	19.5	563	935	1284	6.5	11.4	15.9

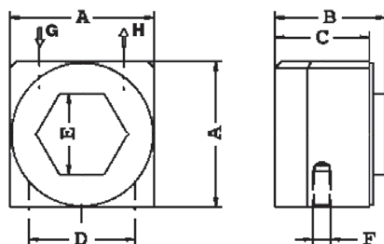

Model	A inches	Width inches	C inches	D inches	E inches	F inches	G Thread BSP	Weight lb
GT-10-RF	1.93	1.50	1.26	1.42	1.06	0.24	1/8"	0.24
GT-16-RF	2.52	1.77	1.54	1.59	1.42	0.31	1/4"	0.45
GT-25-RF	3.07	2.16	1.93	2.36	1.97	0.39	1/4"	0.82

PISTON VIBRATORS FP

PNEUMATIC PISTON VIBRATORS FOR LINEAR VIBRATION WITH UNLIMITED FINE-TUNING FACILITIES FOR AMPLITUDE AND FREQUENCY.



Properties

- Quiet and efficient
- Rated frequency 1'800 – 9'300 vpm
- Force 7 – 962 lbf
- Continuously variable
- Can be used up to 302 °F
- Resistant to extreme environmental conditions
- Also available with ATEX certification

Field of application

- Driving conveyor and discharge chutes
- Loosening or compacting of bulk materials
- Starting up of mechanical processes
- Filling facilities

Construction

Aluminum housing surface-hardened and corrosion-resistant

Model	Vibrations 1000 rpm		Centrifugal Force lbf		Consumption CF min ⁻¹		A Length inches	B SW inches	C Thread mm/inches	D inlet	E Outlet	Weight lb
	30 PSI	90 PSI	30 PSI	90 PSI	30 PSI	90 PSI						
FP-12-S	6.2	9.3	8	21	0.03	0.88	2.80	1.34	M8/0.31	1/8"	1/8"	0.331
FP-12-M	5.0	6.7	8	17	0.02	0.67	3.19	1.34	M8/0.31	1/8"	1/8"	0.384
FP-12-L	4.0	5.4	7	18	0.04	0.71	3.70	1.34	M8/0.31	1/8"	1/8"	0.452
FP-18-S	5.0	7.7	15	42	0.18	2.00	3.19	1.66	M8/0.31	1/8"	1/8"	0.452
FP-18-M	4.0	5.9	15	42	0.14	1.84	3.70	1.66	M10/0.39	1/8"	1/8"	0.754
FP-18-L	3.1	4.6	14	46	0.18	.62	4.30	1.66	M10/0.39	1/8"	1/8"	0.893
FP-25-S	3.6	5.5	28	94	0.46	3.28	3.86	1.97	M10/0.39	1/8"	1/4"	1.157
FP-25-M	3.0	4.2	32	113	0.81	3.07	4.57	1.97	M12/0.47	1/8"	1/4"	1.410
FP-25-L	2.4	3.7	42	134	0.64	3.28	4.36	1.97	M12/0.47	1/8"	1/4"	1.706
FP-35-S	3.8	5.8	66	234	0.81	5.72	3.86	2.56	M12/0.47	1/4"	1/4"	1.940
FP-35-M	3.0	4.6	56	243	0.85	4.98	4.57	2.56	M12/0.47	1/4"	1/4"	2.348
FP-35-L	2.4	3.6	63	240	1.34	4.77	5.36	2.56	M12/0.47	1/4"	1/4"	2.855
FP-50-M	1.85	2.8	110	360	1.67	6.61	4.07	-	-	-	-	6.724
FP-60-M	1.95	2.7	137	489	3.13	9.39	6.07	-	-	-	-	9.039
FP-95-M	1.8	2.8	338	962	5.91	15.64	6.15	-	-	-	-	20.723

FP-50 – 95

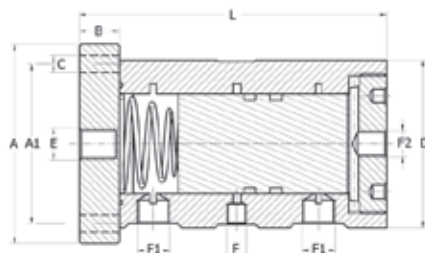

Housing made from hard-anodized aluminum alloy
 Piston made from leaded-bronze
 Steel spring starting device
 Hard anodized aluminum end cap

FP-12 – 35

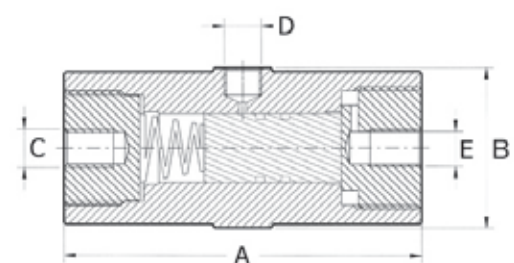

PISTON VIBRATORS FPLF



LUBRICATION-FREE PNEUMATIC VIBRATORS FOR LINEAR VIBRATION WITH UNLIMITED FINE-TUNING FACILITIES FOR AMPLITUDE AND FREQUENCY.

Properties

- Quiet and efficient
- Rated frequency 1'800 – 9'300 vpm
- Force 5 – 962 lbf
- Continuously variable
- Can be used up to 185 °F
- Resistant to extreme environmental conditions
- Also available with ATEX certification

Construction

- Lubrication-free operation possible.
- Extra hard and corrosion-resistant surface through aluminum oxide-generated by titaniferous electrolyte.
- Ideally suited for foodstuffs, drinks and pharmaceuticals.

Field of application

- For foodstuffs and pharmaceuticals, complies with FDA specifications
- Driving conveyor and discharge chutes
- Loosening or compacting of bulk materials
- Starting up of mechanical processes
- Filling facilities

Model	Vibrations 1000 rpm		Centrifugal Force lbf		Consumption CF min ⁻¹		A Length inches	B SW inches	C Thread mm/inches	D inlet	E Outlet	Weight lb
	30 PSI	90 PSI	30 PSI	90 PSI	30 PSI	90 PSI						
FPLF-12-XS	6.0	11.5	5	15	0.03	0.53	1.97	1.46	M8/0.31	1/8"	1/8"	0.231
FPLF-12-S	6.2	9.3	8	21	0.03	0.88	2.80	1.34	M8/0.31	1/8"	1/8"	0.331
FPLF-12-M	5.0	6.7	8	17	0.02	0.67	3.19	1.34	M8/0.31	1/8"	1/8"	0.384
FPLF-12-L	4.0	5.4	7	18	0.04	0.71	3.70	1.34	M8/0.31	1/8"	1/8"	0.452
FPLF-18-S	5.0	7.7	15	42	0.18	2.00	3.19	1.66	M10/0.39	1/8"	1/8"	0.637
FPLF-18-M	4.0	5.9	15	42	0.14	1.84	3.70	1.66	M10/0.39	1/8"	1/8"	0.754
FPLF-18-L	3.1	4.6	14	46	0.18	1.62	4.30	1.66	M10/0.39	1/8"	1/8"	0.893
FPLF-25-S	3.6	5.5	28	94	0.46	3.28	3.86	1.97	M12/0.47	1/8"	1/4"	1.157
FPLF-25-M	3.0	4.2	32	113	0.81	3.07	4.57	1.97	M12/0.47	1/8"	1/4"	1.410
FPLF-25-L	2.4	3.7	42	134	0.64	3.28	5.36	1.97	M12/0.47	1/8"	1/4"	1.706
FPLF-35-S	3.8	5.8	66	234	0.81	5.72	3.86	2.56	M12/0.47	1/4"	1/4"	1.940
FPLF-35-M	3.0	4.6	56	243	0.85	4.98	4.57	2.56	M12/0.47	1/4"	1/4"	2.348
FPLF-35-L	2.4	3.6	63	240	1.34	4.77	5.36	2.56	M12/0.47	1/4"	1/4"	2.855
FPLF-50-M	1.85	2.8	110	360	1.67	6.61	6.07	-	-	-	-	6.724
FPLF-60-M	1.95	2.7	137	489	3.13	9.39	6.07	-	-	-	-	9.039
FPLF-95-M	1.8	2.8	338	962	5.91	15.65	6.15	-	-	-	-	20.723

FPLF-12-XS

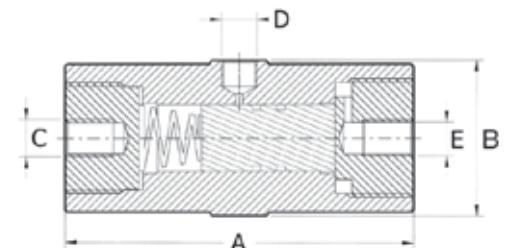

- Housing made from hard-anodized aluminum alloy
- Piston made of steel
- Steel spring starting device
- Sound-absorbing air outlet system
- Hard-anodized aluminum base
- Threaded insert for mounting purposes

PISTON VIBRATORS FAL (lubrication-free) and VTL



PNEUMATIC PISTON VIBRATORS FOR LINEAR VIBRATION WITH UNLIMITED FINE-TUNING FACILITIES FOR AMPLITUDE AND FREQUENCY.

Properties

- Quiet and efficient
- Rated frequency 1'130 – 3'400 vpm
- Force 2,7 – 616 lbf
- Continuously variable
- FAL can be used up to 250 °F, VTL-155 up to 212 °F, remaining VTLs up to 300 °F, FAL HT version up to 300 °F, LT version down to -40 °F on request
- Resistant to extreme environmental conditions
- Also available with ATEX certification

Field of application

- For foodstuffs and pharmaceuticals, complies with FDA specifications (FAL only)
- Driving conveyor and discharge chutes
- Loosening or compacting of bulk materials
- Starting up of mechanical processes
- Filling facilities
- Accessory for FAL: Bellows for ATEX or dusty environment

Construction

- With a freely flying piston, the tapered end of which protrudes from the vibrator's housing.
- Lubrication-free operation possible (FAL).
- Power to weight ratio makes its employment in producing conveying impulses particularly efficient.
- Durable corrosion-resistant surface through aluminum oxide – generated by titaniferous electrolyte (FAL).

Steel housing: Series VTL 165, 255, 405, 555, 855.

Plastic housing: VTL 155.

Model	Vibrations 1000 rpm		Centrifugal Force lbf		Consumption CF min ⁻¹		A Length inches	B ø	C SW inches	D Thread mm/inches	E Inlet mm/inches	F Onlet mm/inches	Weight lb	Piston- Stroke Inches
	30 PSI	90 PSI	30 PSI	90 PSI	30 PSI	90 PSI								
FAL-8	2.05	3.4	2.7	9.5	0.28	1.05	3.59	0.79	0.91	M 6/0.24	M5/0.20	M5/0.20	0.198	1.06
FAL-18	1.42	2.25	13.5	46.5	0.70	2.12	4.61	1.18	1.97	M10/0.31	1/8"	1/8"	1.488	1.30
FAL-25	1.13	2.02	27.0	119.4	1.41	5.47	5.48	2.36	2.56	M16/0.31	1/4"	1/4"	2.899	1.57
FAL-35	1.24	2.01	205	147.5	2.65	12.36	5.52	3.03	-	M16/0.31	1/4"	1/4"	5.181	1.46
VTL-155	1.8	2.7	9.0	21.6	0.64	3.00	4.49	1.97	-	M10/0.39	1/8"	1/8"	1.224	1.34
VTL-165	1.9	2.6	9.7	21.6	0.60	2.47	4.37	1.93	-	M10/0.39	1/8"	1/8"	3.329	1.38
VTL-255	1.6	2.2	18.0	90.0	2.00	6.36	5.52	2.52	-	M16/0.39	1/4"	1/4"	7.099	1.77
VTL-405	1.4	2.0	45.0	146.1	2.83	13.77	5.52	3.31	-	M16/0.47	1/4"	1/4"	11.971	1.77
VTL-555	1.6	2.5	101.2	293.4	4.94	25.32	4.93	4.53	-	M20/0.47	3/8"	3/8"	19.621	1.48
VTL-855	1.8	2.6	137.4	344.0	10.63	31.78	4.81	6.30	-	M20/0.47	3/8"	3/8"	37.699	1.37
VTL-1105	2.1	3.0	348.5	616.0	12.18	32.49	4.81	7.87	-	M20/0.47	1/2"	3/8"	56.945	1.29

Housing made from hard-anodized aluminum alloy, steel or plastic

Piston made from leaded-bronze or steel

Threaded insert for mounting purposes

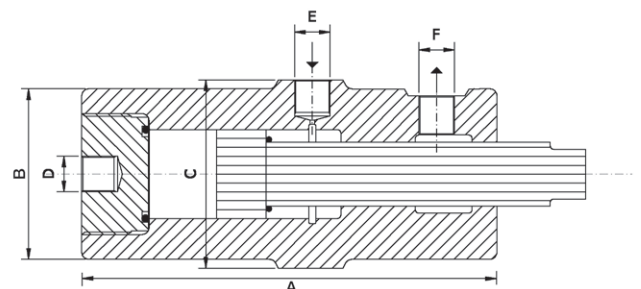

HIGH-FREQUENCY KNOCKERS FPK



Properties

- High impact frequency 1'350 – 4'600 vpm
- High power range 44 – 12'668 lbf
- Lubrication-free
- Can be used up to 248°F, HT version up to 302°F and LT version down to -40 °F on request
- Can be used in dusty environments
- Also available with ATEX certification

Field of application

Broad field of application, for example knocking off adhering material from container walls such as silos, chutes, filter outlets, reactors and pipelines.

Construction

- With the FPK-knockers compressed air pushes a piston in a linear direction (vibration).
- When used as a high frequency knocker, the piston shoots against a plastic baffle plate supplied with the knocker.
- Additional impact regulation is provided by baffle plates of varying hardness.

Model	Baffle Plate	Vibrations 1000 rpm			Centrifugal Force lbf			Consumption CF min ⁻¹			Weight lb
		30 PSI	60 PSI	90 PSI	30 PSI	60 PSI	90 PSI	30 PSI	60 PSI	90 PSI	
FPK-40	none	2100	2400	2800	44	102	164	3.3	5.3	7.9	2.64
	soft	2800	3900	4600	881	2340	3379	3.5	6.9	12.7	
	hard	2800	3900	4600	1628	3370	5114	3.5	6.9	12.7	
FPK-55	none	1350	1750	2050	115	262	446	5.7	12.7	16.6	10.3
	soft	2200	3400	4300	1221	4791	8221	8.1	13.4	17.7	
	hard	2200	3400	4300	3950	3950	12668	8.1	13.4	17.7	

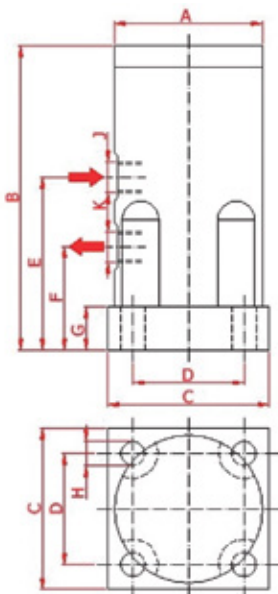

Model	A inches	B inches	C inches	D inches	E inches	F inches	G inches	H inches	J inches	K inches
T-50/LP	2.68	5.51	2.91	2.00	3.15	1.89	0.79	0.43	1/4"	1/4"
T-50-HP	3.70	7.52	4.09	3.07	4.37	2.36	0.98	0.51	3/8"	3/8"

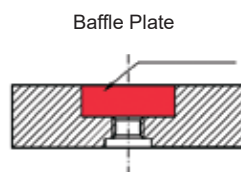

The FPK can be recycled.
 Housing: Aluminum, hard-anodized
 Base, lid: Aluminum, hard-anodized
 Piston: Steel, PTFE-coated
 Baffle plate: Plastic

KNOCKERS 〈FKL IN〉



Properties

- Single or interval impact mode
- Variable impact force and interval
- Lubrication-free
- Flexible range of application
- Can be used up to 185°F, HT version up to 302°F and LT version down to -40° F on request
- Also available with ATEX certification

Field of application

Broad field of application. Knocking off adhering material from container walls such as silos, chutes, filter outlets, reactors and pipelines.

Construction

A piston is forced against a spring by compressed air. With rapid venting, the piston closes against a baffle plate. Knocker housing made of aluminum, baffle plate made of impact-resistant special plastic.

Interval impact mode

The impact depends on the interval time which is set by means of a throttle valve.

The force is adjusted by the three control bores 1 - 3.

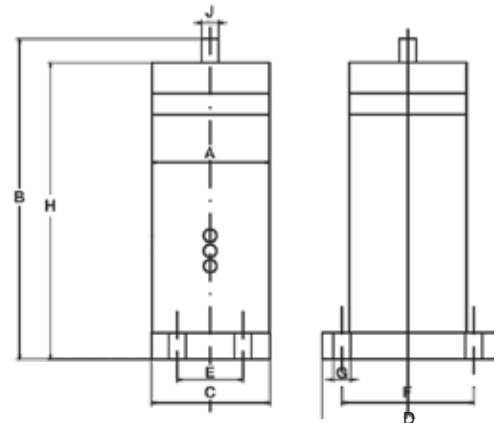
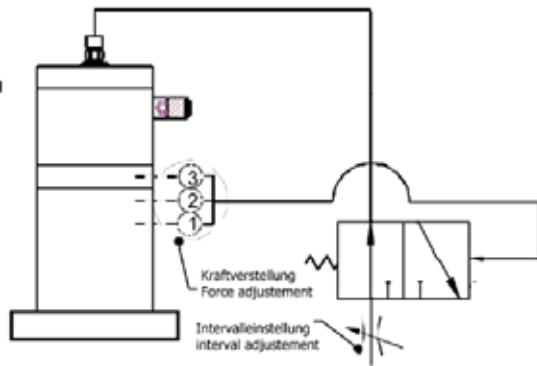

Model	A inches	B inches	C inches	D inches	E inches	F inches	G inches	M inches	N inches
FKL-25in	ø 2.05	6.69	2.09	3.46	-	2.76	0.35	6.02	0.51
FKL-50in	ø 2.52	7.64	2.60	4.53	-	3.54	0.51	6.97	0.51
FKL-100in	ø 3.50	9.53	3.54	5.12	1.97	3.94	0.51	8.82	0.51
FKL-150in	ø 4.65	12.99	-	ø 5.51	-	ø 4.53	0.51	12.20	0.51
FKL-200in	ø 5.80	13.3	-	ø 7.09	-	ø 5.98	0.67	12.6	0.51

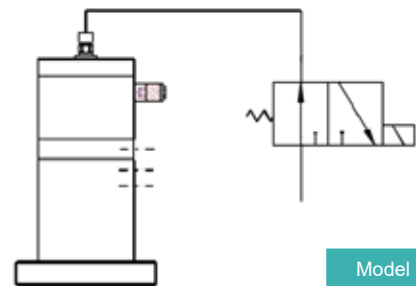

Model	Min. op. Pressure (PSI) Control bores No.			Work/Impact Foot-Pounds	Impulse/Impact lbf	Stroke VPM	Air Consumption CF/stroke	Max Wall Thickness inches	Weight lb
	①	②	③						
FKL-25in	43.5	65.3	94.3	0.7 - 5.2	0.11 - 0.23	max. 10	0.2 - 0.32	0.079	2.271
FKL-50in	43.5	65.3	94.3	3.7 - 15.5	0.23 - 0.79	max. 10	0.28 - 1.08	0.118	4.079
FKL-100in	58.0	72.5	94.3	7.4 - 51.6	0.23 - 2.36	max. 10	0.48 - 2.69	0.197	9.921
FKL-150in	76.9	97.2	116.0	36.9 - 144.6	0.23 - 6.53	max. 10	2.39 - 9.34	0.315	20.944
FKL-200in	76.9	97.2	116.0	73.8 - 206.5	0.23 - 12.94	max. 10	6.62 - 18.52	0.472	32.628

KNOCKERS FKL mi

Properties

- Multiple impact mode
- Impact force and interval adjustable
- Lubrication-free
- Can be used up to 185° F
- HT version up to 302°F and LT version down to -40°F on request
- Flexible range of application
- Also available with ATEX certification



Field of application

Broad field of application, also outdoors, wet- and EX-area. Knocking off adhering material from container walls such as silos, chutes, filter outlets, reactors and pipelines.

Construction

A piston is forced against a spring by compressed air. When the impact piston passes the control outlet duct, it is vented suddenly and the piston is shot against a baffle plate made of impact-resistant special plastic. The piston closes off the air duct and the procedure is repeated at the speed set by the throttle.

Model	Pressure PSI	Work/Impact Foot-Pounds	Impulse/ Impact lbf	Stroke Impacts pm	Air Consumption CF/stroke	Max. Wall Thickness	Weight lb
FKL-25in	87 - 116	7.38 - 29.50	1.125 - 2.25	0.5 - 10	0.018 - 0.039	0.197	9.921

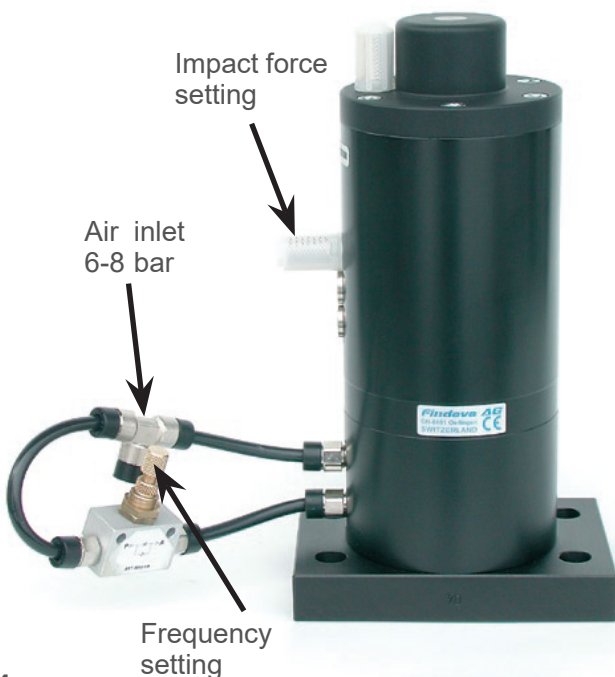

Housing made of hard-anodized aluminum alloy
Steel piston
Baffle plate made of impact-resistant plastic

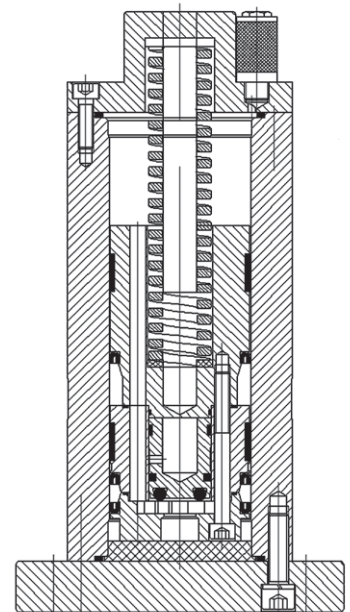

VAC-ATTACK™

VIBRATOR VACUUM-MOUNT

WORKMASTER®
WE FIND A WAY — OR MAKE ONE!

The **VAC-ATTACK™** Portable Vacuum-Mount (PVM) Vibrators are the ideal choice when ease of installation or maximum portability is required. PVM Vibrators combine energy-efficient, quiet, rotary or non-impacting linear vibration with dependable, instant mount to any clean, relatively-smooth flat or curved surface. With a wide range of models and sizes, we have the right VAC-ATTACK™ PVM Vibrator for your application.



EXACT PLACEMENT

The Vacuum Mount enables the vibrator to be placed at the ideal location for prompting and maintaining product flow.

UNPARALLELED CONTROL

Frequency and amplitude are infinitely and independently adjustable by controlling air pressure and flow rate of exhaust air.

EASY TO MOVE

The light-weight PVM Vibrators can easily be moved from job-to-job by one worker. The largest, most powerful VAC-ATTACK unit weighs less than 35-lbs.

INSTANT MOUNT

No brackets, fasteners, or welding. Put a PVM vibrator in place, activate the control switch, and the unit holds its position before, during and after vibration.

APPLICATION FRIENDLY

Starts in any position and stops instantly. Can be used in a wide variety of flat and curved surfaces in ambient temperatures to 140° F.

ENERGY EFFICIENT

Compared with other air vibrators, PVM Vibrators produce twice the force lbs per CFM of compressed air consumed.

LOW NOISE

Rotary, turbine, and non-impacting linear vibrators provide the force of comparably sized ball, roller, and piston vibrators to effectively move even stubborn

APPLICATIONS INCLUDE:

- Barrel Compaction
- Chutes & Pipes
- Concrete Forms
- Downcomer Pipes
- FIBC Loading & Unloading
- Hummer Screens
- Packaging
- Railcars, Bins, Hoppers
- Storage Vessels
- Trucks Tote Bins & Batch
- Vibratory Stress Testing

BANDWIDTHS AND FREQUENCIES OF THE FORCES

Frequency – Vibrations per minute

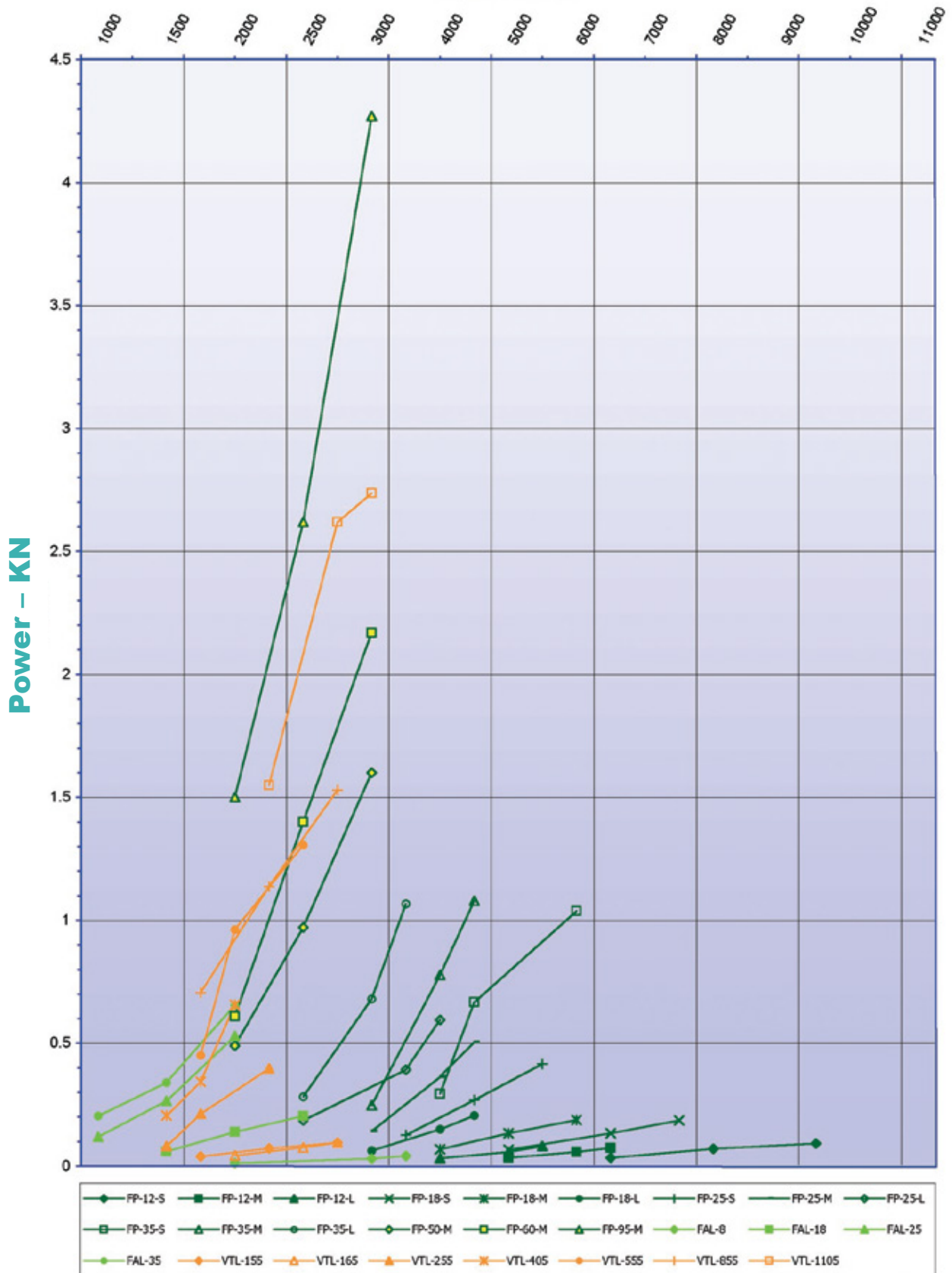

BANDWIDTHS AND FREQUENCIES OF THE FORCES

Frequency – Vibrations per minute

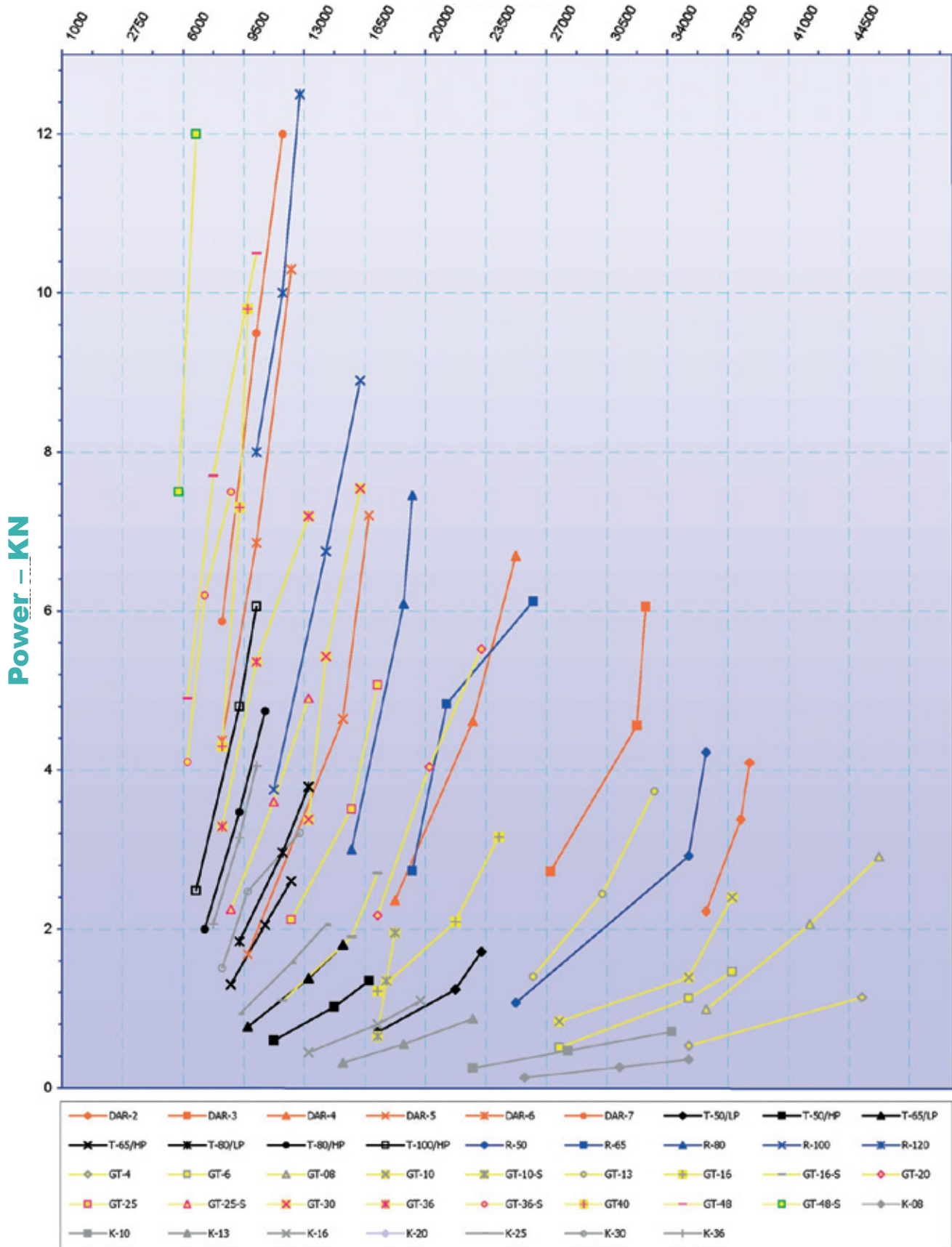

EVALUATION OF THE RIGHT VIBRATOR

Functional principles:

- Rotating vibrators for non-directional circular oscillations: Series K, R, DAR, T, GT
- Linear vibrators for linear aligned oscillations: Series FP, FPLF, FAL, VTL
- Interval knockers: Series FKL, FPK

You choose the vibration characteristics:

- Mainly high-frequency oscillations with low amplitude: Series K, R, DAR, T, GT
- Low-frequency oscillations with high amplitude: Series FP, FPLF, FAL, VTL
- Hammer impacts: Series FKL, FPK





VIBRATEK

Applied Vibration Technology



Vibratek industrial vibration products are designed to increase the efficiency of moving, loading and unloading of storage and bulk solids. With an extensive line of rugged, industrial quality products, Vibratek has the right product for your material flow applications.

To view our full line of vibration products and accessories visit:

vibratek.net



VIBRATEK

Applied Vibration Technology

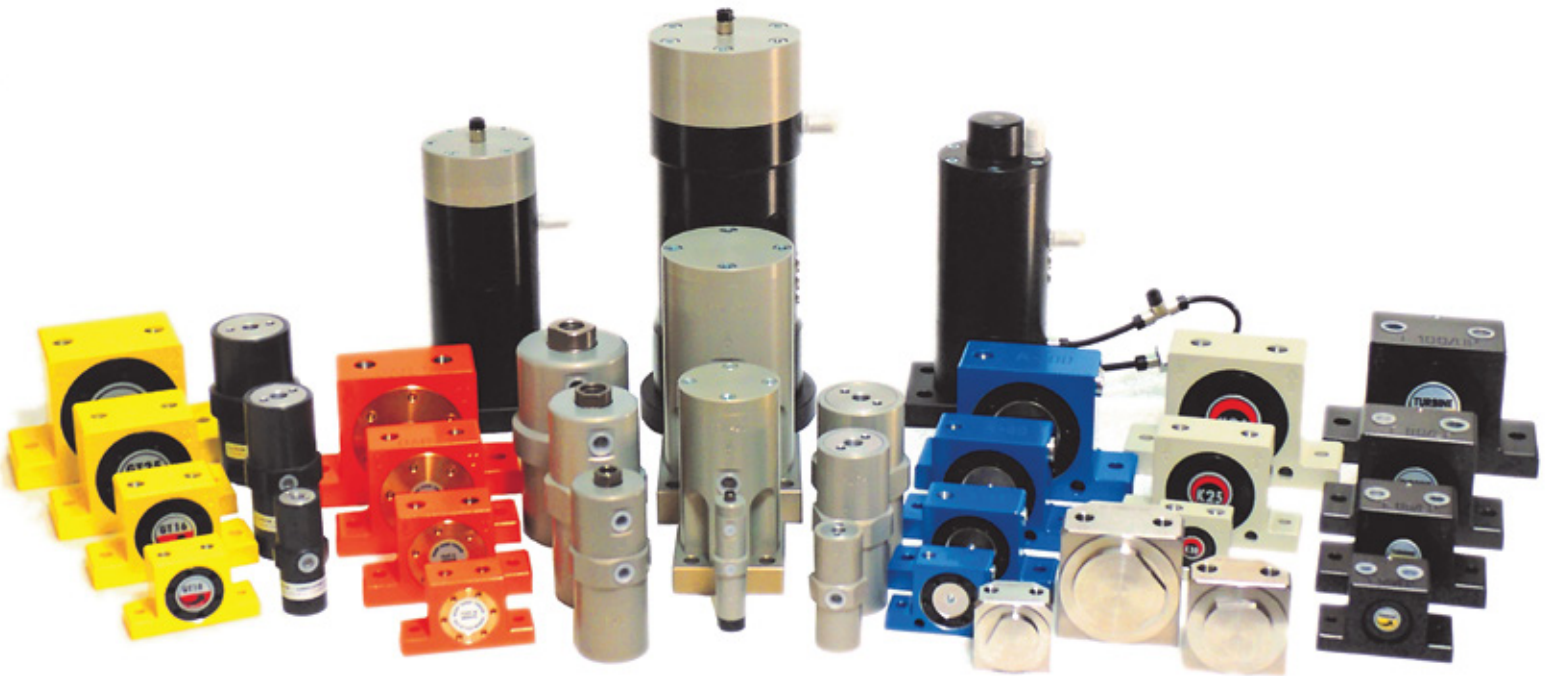

PNEUMATIC VIBRATORS:

Highest Power to Weight Ratio; Lowest Air Consumption Longest Life Expectancy;
Greatest Force & Frequency Control; Lowest Maintenance

70 MODELS

vibratek.net

284 Three Tun Road Malvern, PA 19355-3981 • USA

Email: sales@vibratek.net Phone: 888.842.6977 Fax: 888.842.6966