

AIRMATIC®

WE'LL HANDLE IT.

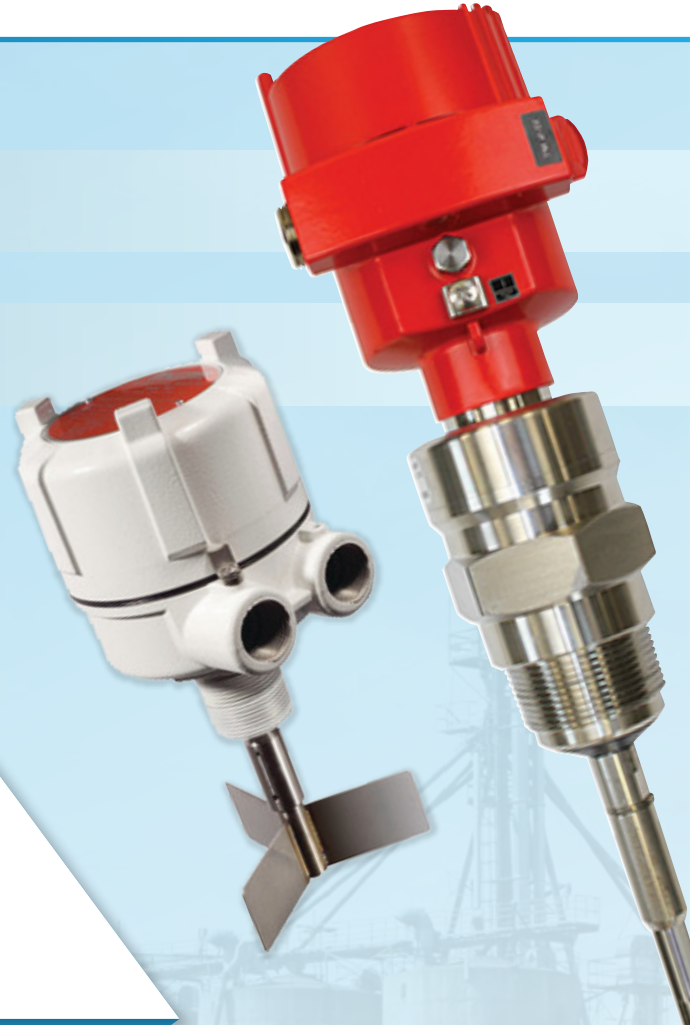

BINMASTER®

LEVEL, FLOW & DUST

DETECTION CONTROLS FOR POWDERS AND BULK SOLIDS

AIRMATIC

284 Three Tun Rd. Malvern, PA 19355

215.333.5600

infocenter@airmatic.com

airmatic.com

WHY BINMASTER?

With bin level indicators installed, there is no need to scale ladders or climb onto bin roofs to routinely check bin levels. This reduces the risk of accidents and helps companies avoid insurance claims due to falls and injuries. Plus, for volatile or dusty materials, we offer products with explosion-proof certifications to prevent accidents.

SIMPLE OPERATION

BINMASTER level, flow, and dust detection controls are easy to install and operate. Designed with simplicity and convenience in mind, our wide range of controls does not require highly skilled technical or operational staff or continual reference to complicated manuals. Over the long term, BINMASTER equipment is designed for minimal, easy service.

HIGHLY COST EFFECTIVE

BINMASTER features a comprehensive line of products, providing a solution for a wide variety of applications for every budget. Basic devices offered at a very low cost will pay for themselves quickly in labor savings alone. Optimizing storage capacity and replenishment cycles makes even the most advanced BINMASTER system a fast return on investment. Designed to help Customers save money, BINMASTER systems use less equipment to monitor more bins, can be configured to tie into existing control systems, and feature low power consumption and operating costs.



SAVES TIME

BINMASTER Level Indicators require fewer people to do more work by eliminating frequent climbing and allowing multiple bins to be monitored from a central location. With systems to manage from 1 up to 120 bins, there is no time wasted going to each bin. Many of our devices also offer a “fail-safe” feature which gives an immediate warning and instantaneous response in the event of a failure.

PREVENTS BIN OVERFLOW

Overfilling bins ruin materials, waste time, make a mess, and cost money. Installing bin level controls allows users to automatically monitor materials and control processes. By managing material storage and flow, users can prevent bin overflows, empty conditions, clogged chutes and jammed conveyors. This helps eliminate costly spills, material waste, and unnecessary downtime.

IMPROVES INVENTORY MANAGEMENT

From simple point level controls to advanced inventory management systems, BINMASTER can help an operation run more efficiently, and inventory levels will be more accurate. Information regarding bin status will be timely, allowing for just-in-time replenishment and reducing the risk of shutting down operations if material should run out. Advanced systems like SmartBob® (Page 14) allow users to view multiple bins at a glance, helping to alleviate stress on production and purchasing personnel.



PRODUCT SELECTION CHART

- = Applicable
- = Consult AIRMATIC

	Point Level										Continuous Level				Flow & Dust						
	PROCAP I & II Cap. Probe	PRO REMOTE Cap. Probe	PROCAP I & II FL Cap. Probe	PRO HTRC 20 Cap. Probe	COMPACTPRO Cap. Probe	BMRX Rotary	MAXIMA+ Rotary	VR-21 Vibrating Rod	VR-41 Vibrating Rod	CVR-600 Vibrating Rod	SHT 120 Vibrating Rod	Diaphragm Switch	Tilt Switch	SMARTBOB 2	SMARBOB - TS1	3D Level Scanner	SMARTSONIC	SMARTWAVE	FLOW DETECT 1000	DUST DETECT 1000	BM-30 LGX Part Monitor
MATERIAL																					
Powder	●	●	●	●	●	●	●	●	●	●	●	●	●	●	●	●	●	●	●	●	●
Granular	●	●	●	●	●	●	●	●	●	●	●	●	●	●	●	●	●	●	●	●	●
Slurry	●	●	●	●	●	●	●	●	●	●	●	●	●	●	●	●	●	●	●	●	●
Liquid	●	●	●	●	●	●	●	●	●	●	●	●	●	●	●	●	●	●	●	●	●
MATERIAL DENSITY																					
Low	●	●	●	●	●	●	●	●	●	●	●	●	●	●	●	●	●	●	●	●	●
High	●	●	●	●	●	●	●	●	●	●	●	●	●	●	●	●	●	●	●	●	●
MATERIAL MOISTURE																					
Low	●	●	●	●	●	●	●	●	●	●	●	●	●	●	●	●	●	●	●	●	●
High	●	●	●	●	●	●	●	●	●	●	●	●	●	●	●	●	●	●	●	●	●
TEMPERATURE																					
High	●	●	●	●	●	●	●	●	●	●	●	●	●	●	●	●	●	●	●	●	●
PRESSURE																					
Atmospheric	●	●	●	●	●	●	●	●	●	●	●	●	●	●	●	●	●	●	●	●	●
Low	●	●	●	●	●	●	●	●	●	●	●	●	●	●	●	●	●	●	●	●	●
High	●	●	●	●	●	●	●	●	●	●	●	●	●	●	●	●	●	●	●	●	●
VIBRATION																					
Low	●	●	●	●	●	●	●	●	●	●	●	●	●	●	●	●	●	●	●	●	●
High	●	●	●	●	●	●	●	●	●	●	●	●	●	●	●	●	●	●	●	●	●
MATERIAL COATING																					
Minimal	●	●	●	●	●	●	●	●	●	●	●	●	●	●	●	●	●	●	●	●	●
Heavy Build-Up	●	●	●	●	●	●	●	●	●	●	●	●	●	●	●	●	●	●	●	●	●
CORROSIVE																					
Low	●	●	●	●	●	●	●	●	●	●	●	●	●	●	●	●	●	●	●	●	●
High	●	●	●	●	●	●	●	●	●	●	●	●	●	●	●	●	●	●	●	●	●
INSTALLATION																					
Top-Mounted	●	●	●	●	●	●	●	●	●	●	●	●	●	●	●	●	●	●	●	●	●
Side-Mounted	●	●	●	●	●	●	●	●	●	●	●	●	●	●	●	●	●	●	●	●	●
ATMOSPHERE																					
Dust	●	●	●	●	●	●	●	●	●	●	●	●	●	●	●	●	●	●	●	●	●
Steam	●	●	●	●	●	●	●	●	●	●	●	●	●	●	●	●	●	●	●	●	●
Vapor	●	●	●	●	●	●	●	●	●	●	●	●	●	●	●	●	●	●	●	●	●

ROTARY LEVEL INDICATORS

“Tried and True Point Level Measurement!”

Rotary Level Indicators are proven, widely used devices for point level detection and are suitable for a wide range of powder and bulk solid materials. BINMASTER Rotaries feature a specialized motor design with “de-energized” operation, shutting down the motor when material is present, prolonging motor life and saving energy. A triple-thread, screw-off lid offers easy access to components while dual-conduit entries allow for simple installation. With options like “fail-safe” protection alert to prevent loss of power, and models for hazardous locations, BINMASTER Rotaries are best-in-class for the industry.

BMRX STANDARD ROTARY LEVEL INDICATOR

The **BMRX Standard Rotary Level Indicator** is BINMASTER’s most popular Rotary Level Indicator, featuring a basic, reliable, and rugged design that provides for simple, dependable operation. The BMRX Rotary is a proven technology used to prevent bin overflow and is used as a high or low level control for a wide variety of bulk solid materials, including granulars, pellets, or powders — providing alerts when a bin reaches a full or empty condition.

FEATURES

- Rugged Construction and Simple, Dependable Design
- Triple-Thread Screw-Off Cover
- Switch Selectable High / Low Fail-Safe
- De-Energizing Motor for Extended Operational Life
- Four-Bearing Shaft Assembly Reduces Wear and Increases Reliability
- Internal, Bi-Directional Clutch
- Various Voltages Available
- DPDT Relay Output, 250 VAC, 10 Amp
- Dual Conduit Entrance
- Removable Wiring Terminals
- Interchangeable with Other Rotaries
- Powder-Coated Finish
- Adjustable Sensitivity

APPLICATIONS: Feed, Seed, Grain, Food, Sand, Gravel, Concrete, Aggregates, Plastics, Chemicals, Coal, and other material densities from 2 lbs/ft³ to over 100 lbs/ft³.

MAXIMA+ GENUINE FAIL-SAFE ROTARY LEVEL INDICATOR

The **MAXIMA+ Genuine Fail-Safe Rotary Level Indicator** is BINMASTER’s most advanced Rotary Level Indicator. Microprocessor-based, it offers genuine fail-safe protection. Its distinguishing feature is its ability to continuously self-diagnose, and in the event of a failure — whether power, the motor, or electronics — the MAXIMA+ provides an immediate red LED indicator alert via on the top of the unit. The MAXIMA+ is the rotary of choice when continuous operation is crucial.

FEATURES

- Microprocessor-Based Fail-Safe Indicator Eliminates Spills and Process Shortages from Power Failures, Motor, or Gear Failures
- Visual LED Indicates Sensor Status: Uncovered, Covered, and Fault Conditions
- Supervises Normal and Fault Conditions
- De-Energizing Motor for Extended Operational Life
- Four-Bearing Drive Shaft Assembly Reduces Wear and Increases Reliability
- Triple-Thread Screw-Off Cover
- Internal, Bi-Directional Clutch
- Multiple Voltages
- Interchangeable with Other Rotaries
- Powder-Coated Finish
- Adjustable Sensitivity

APPLICATIONS: Feed, Seed, Grain, Food, Sand, Gravel, Concrete, Aggregates, Plastics, Chemicals, Coal, and other material densities from 2 lbs/ft³ to over 100 lbs/ft³.



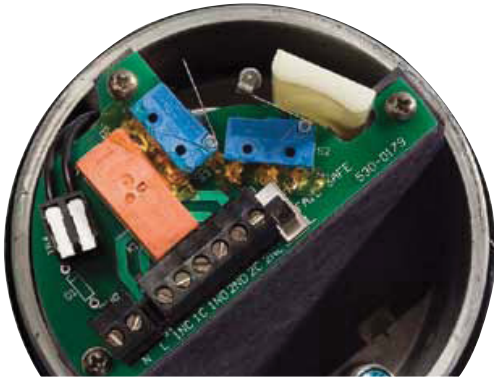

HIGH & LOW DETECTION

MINI ROTARY LEVEL INDICATOR

The **Mini Rotary Level** Indicator is an economical, compact rotary level control designed for use in small bins and hoppers. Its small size allows the Mini Rotary to be installed in space-constrained bins that still need reliable level control. It is easy to install and is used in a variety of materials including plastics, feed, seed, chemicals, and other powder or bulk materials.



Ideal for small bins in tight spaces!

FEATURES

- Compact Design Ideal for Small Bins, Hoppers, and Feeders
- Easy-to-Install
- No Calibration Required
- De-Energizing Motor Extends Motor Life
- Motor Slip-Clutch Prevents Gear Damage
- Adjustable Sensitivity
- 3/4 Pipe Fitting
- Optional 4-Vane or Bayonet-Type Polycarbonate Sensing Paddles

APPLICATIONS: Powders, Pellets, Granular Materials, Feed, Seed, Grain, Food, Plastics, Chemicals, and other material densities from 2 lbs/ft³ to over 30 lbs/ft³.

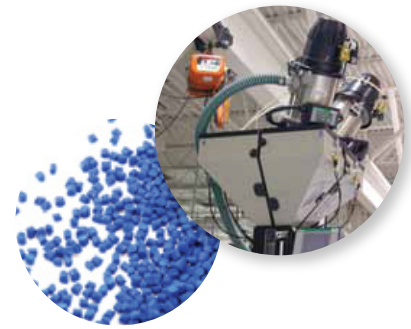

CUSTOM OPTIONS & CONFIGURATIONS

SEALED ROTARY EXTENSION

BINMASTER's Sealed Rotary Extension Design includes a protective bearing at the bottom of the shaft and the shaft guard. This bearing prevents bin material from getting backed up into the extension and causing the rotary to give a false "full" signal when the paddle stops turning. A Rotary Extension can be integrated with either the MAXIMA+ or BMRX Rotary Level Indicators. An extended rotary can also be used when side mounting or on angled rooftops.

HORIZONTAL ROTARY EXTENSION

The Horizontal Rotary Extension provides the ability to install a rotary on the side of a bin wall, such as those in concrete silos, up to 12" thick. This Extension allows for rotaries to be side-mounted with minimal risk of damage during operations. This optional assembly includes an extended drive shaft with a protective shaft guard that keeps the shaft centered, and BINMASTER's "no packing" seal at the end of the shaft. Standard lengths of 6", 8", 10", or 12" available for the MAXIMA+ or BMRX Rotary Level Indicators.

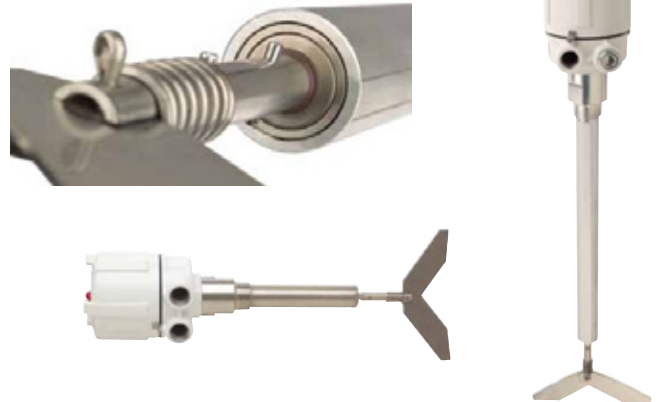

VERTICAL ROTARY EXTENSION FOR HIGH LEVEL DETECTION

Top-of-bin mounting for rotaries is ideal when the rotary is used as a high level alarm. Solid material will tend to be higher at the filling point. Most operators don't want any bin filled to the very top and need to allow for a specified amount of headroom in the bin. For top-of-bin applications, BINMASTER manufactures to the length requested, offering custom lengths up to 144".

CAPACITANCE PROBES

Capacitance Probes are used for high-level and low-level detection in bins, silos, tanks, hoppers, chutes, and other vessels used for material storage or process manufacturing. They detect the presence or absence of material in contact with the probe by sensing minute changes (as low as 0.5 pF) in capacitance caused by the difference in the dielectric constant of the material vs the air. They feature a Class II hazardous location rating and are available with a wide assortment of probes and extensions to meet a variety of processing needs.

PROCAP I & II CAPACITANCE PROBES

PROCAP I & II Capacitance Probes provide interference-free operation — working far below the RF level of 9 KHz at just 6 KHz, they will not interfere with two-way radios or other equipment operating in the radio spectrum. They feature simple “quick-set” calibration and fail-safe operation including a visual LED to indicate the sensor status. Accurate level detection is assured even in dusty, sticky, or clinging materials by the PRO-Shield feature, which compensates for material build-up on the sensing probe. It also provides fail-safe protection in the event of a power failure as well as an adjustable time delay to help prevent false readings.

FEATURES

- “Quick-Set” Simple Calibration
- Triple-Thread Screw-Off Cover
- Dual Conduit Entrance
- Unsurpassed Sensitivity (0.5 pF)
- PRO-Shield Compensates for Material Build-Up
- Fail-Safe, Switch Selectable High / Low
- Adjustable Time Delay to 30-Seconds
- Optional Sensing Probes: DELRIN or TEFLON Sleeved, Bare, Food Grade, Flush Mount, Solid and Flexible Extensions
- Visual LED indicates Sensor Status: Uncovered, Covered, or Power Failure

APPLICATIONS: Plastics, Chemicals, Coal / Fly Ash, Concrete, Food Ingredients, Pharmaceuticals, Feed and Grain, Mining, Foundries, Wood and Paper Processing, and other materials.



PROCAP IX & IIX CAPACITANCE PROBES

PROCAP IX & IIX Capacitance Probes are designed for use in hazardous locations, featuring CSA Class I, Groups C & D and Class II, Groups E, F & G Ratings. They are suitable in challenging environments where there is a risk of explosion, for detecting high and low levels in bins, silos, tanks, hoppers, chutes, and other vessels used for volatile materials storage or process manufacturing.

FEATURES

- Explosion-Proof Design for Class I Hazardous Location Applications
- “Quick-Set” Simple Calibration
- Triple Thread Screw-Off Cover
- Dual Conduit Entrance
- Unsurpassed Sensitivity (0.5 pF)
- PRO-Shield Compensates for Material Build-Up
- Operates below RF Range, Temperature Stable Calibration and Protection from RF Interference
- Fail-Safe, Switch Selectable High / Low
- Adjustable Time Delay to 30-Seconds
- Optional Sensing Probes: DELRIN or TEFLON Sleeved, Food Grade, Flush Mount, Solid & Flexible Extensions

APPLICATIONS: Plastics, Chemicals, Coal / Fly Ash, Concrete, Food Ingredients, Pharmaceuticals, Feed and Grain, Mining, Foundries, Wood and Paper Processing, and other materials.





“Interference-Free Operation”

PROCAP I 3-A & II 3-A CAPACITANCE PROBES

BINMASTER PROCAP I 3-A & II 3-A Capacitance Probes meet rigorous USDA, FDA, and 3-A material and design standards for sanitary food and dairy processing. They can be used for high- and low-level detection in bins, silos, tanks, hoppers, chutes, and other vessels used for storage or manufacture of food or dairy products.



FEATURES

- 3-A Approved, Food Grade Design
- “Quick-Set” Simple Calibration
- Triple-Thread Screw-Off Cover
- Dual Conduit Entrance
- Unsurpassed Sensitivity (0.5 pF)
- PRO-Shield Compensates for Material
- Operates Below RF Range, Temperature Stable Calibration and Protection from RF Interference
- Fail-Safe, Switch Selectable High / Low
- Adjustable Time Delay to 30-Seconds
- Visual LED Indicates Sensor Status: Uncovered, Covered, or Power Failure

APPLICATIONS: Dairy Products, Food, Pharmaceuticals, and other materials requiring 3-A, FDA, or USDA approval.



PROCAP I & II FL CAPACITANCE PROBES

BINMASTER PROCAP I & II FL Capacitance Probes offer “no probe intrusion” and are designed for space constrained areas, or applications where material flow or bridging may damage a standard probe. They can be mounted on bin walls, conveyor housings, or chutes. The bottom face of the FL serves as the capacitance sensor which features PRO-Shield compensation for material build-up and an adjustable time delay of up to 30-seconds to ensure accurate readings.

FEATURES

- “Quick-Set” Simple Calibration
- Triple-Thread Screw-Off Cover
- Dual Conduit Entrance
- Unsurpassed Sensitivity (0.5 pF)
- PRO-Shield Compensates for Material Build-Up
- Operates Below RF Range, Temperature Stable Calibration and Protection from RF Interference
- Fail-Safe, Switch Selectable High / Low
- Adjustable Time Delay to 30-Seconds
- Visual LED Indicates Sensor Status: Uncovered, Covered, or Power Failure

APPLICATIONS: Plastics, Chemicals, Coal / Fly Ash, Concrete, Food Ingredients, Pharmaceuticals, Feed and Grain, Mining, Foundries, Wood and Paper Processing, and other applications where a non-intrusive flush mounted sensor is necessary.



*Special Bin Wall Adapter available when working with thick walls or angled hoppers

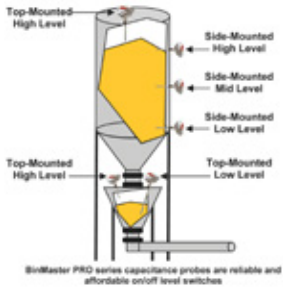

CAPACITANCE PROBES

Capacitance Probes can be used for high, mid, and low-level indication, and may be mounted vertically, horizontally, or on a 30° angle. Flexible Extensions can also be used for top mount application in lengths up to 35' for high level indication. Flush Mount Probes are ideal for space-constrained areas or where material flow or bridging may damage standard probes.

Can't decide which Capacitance Probe is right for you? Send us the data sheet specifics of your application!

PRO REMOTE CAPACITANCE PROBES

BINMASTER **PRO REMOTE Capacitance Probes** feature remote electronics located in a housing that is separated from the probe, making it suitable for high temperature, high vibration, or hazardous environments. They are CSA Class II listed and allow for the electronics to be installed up to 75-feet from the sensing probe and the hostile conditions, depending on the required sensitivity. The PRO-Shield feature protects against false readings due to coating or material build-up on the probe, while an adjustable time delay of .25 to 10-seconds can be set to ensure the most accurate readings.

FEATURES

- "Quick-Set" Simple Calibration
- Unsurpassed Sensitivity (0.5 pF)
- PRO-Shield Compensates for Material Build-Up
- Fail-Safe, Switch Selectable High / Low
- Operates Below RF Range, Temperature Stable Calibration and Protection from RF Interference
- Adjustable Time Delay to 10-Seconds
- Optional Sensing Probes: DELRIN or TEFLON Sleeved, Bare, Food Grade, Flush Mount, Solid and Flexible Extensions
- Visual LED Indicates Materials in Contact with Probe

APPLICATIONS: Plastics, Chemicals, Coal / Fly, Concrete, Food Ingredients, Pharmaceuticals, Feed and Grain, Mining, Foundries, Wood and Paper Processing, and other materials. Electronics may be located up to 75' from sensing probe.



PRO AUTO CAL CAPACITANCE PROBES

BINMASTER **PRO AUTO CAL Capacitance Probes** offer simple and automatic calibration and external testing without having to remove the cover of the unit. Calibration takes just seconds and is performed with the use of a special magnet. This unit also allows for the simulation of either a covered or uncovered condition without accessing the probe assembly or the electronics, and unsurpassed sensitivity of 0.5 pF for enhanced accuracy.

FEATURES

- Auto-Calibration and External Test
- Unsurpassed Sensitivity (0.5 pF)
- PRO-Shield Compensates for Material Build-Up
- Operates Below RF Range, Temperature Stable Calibration and Protection from RF Interference
- Fail-Safe, Switch Selectable High / Low
- Adjustable Time Delay to 10-Seconds
- Optional Sensing Probes: DELRIN or TEFLON Sleeved, Food Grade, Flush Mount, Solid & Flexible Extensions

APPLICATIONS: Plastics, Chemicals, Coal / Fly Ash, Concrete, Food Ingredients, Pharmaceuticals, Feed and Grain, Mining, Foundries, Wood and Paper Processing, and other applications where low voltage DC power is necessary.



For more technical information and custom options, request our complete catalog on BINMASTER Capacitance Probes.

BELOW THE RF LEVEL

COMPACT PRO CAPACITANCE PROBES

BINMASTER **COMPACT PRO Capacitance Probes** are simple to set up and require virtually no maintenance. Their compact design makes them easy to install and a simple “one-time” calibration procedure with sensitivity less than 1 pF ensures fast set-up. They require no routine preventative maintenance and their operation is unaffected by temperature changes, eliminating the need for recalibration. The COMPACT PRO is designed for tight spaces where proximity switches will not work, and features four levels of static discharge protection, which are important for pneumatically conveyed materials.



FEATURES

- PRO-Shield Detection Feature Ignores Material Build-Up
- LED on Housing Indicates Sensor Status: Covered or Uncovered
- Easy “One-Time” Calibration
- Compact Design and Easy-to-Install
- For Metal, Plastic, or Other Non-Metallic Vessels

APPLICATIONS: Plastics, Chemicals, Concrete, Food Ingredients, Pharmaceuticals, Feed and Grain, Wood and Paper Processing, and other smaller applications where proximity switches won't work.



CAPACITANCE 101

Capacitance Probes function like big capacitors. A capacitor is an electrical device formed by two conductors and separated by an insulator. The two conductors are represented by the active portion of the probe, and the wall of the metal vessel. The probe energizes the conductors and measures the capacitance that exists between them. The amount of capacitance depends upon the size of the conductors, the physical space between the conductors, and the dielectric of the material between them. The dielectric constant of a material is a unitless number, derived from the ratio of the amount of capacitance produced when material is present, compared to the amount produced when only air is present.

A PRO-Shield on the BINMASTER Probes is designed to overcome problems resulting from sidewall build-up, or bridging between the sidewall and probe. A shield is an energized portion of the probe not used for sensing material. The first five inches of the shaft as it extends out from the enclosure make up the shield (see diagram). The probe examines a large area around itself, not just the area in direct contact. This allows the probe to ignore build-up which can occur on the probe assembly. This also allows use of a sleeved probe.

BINMASTER's PROCAP Series Capacitance Probes use advanced integrated circuit technology operating at a low frequency to achieve both high sensitivity and stable calibration. The probe uses a simple timing technique that compares the discharge time of the probe capacitance.

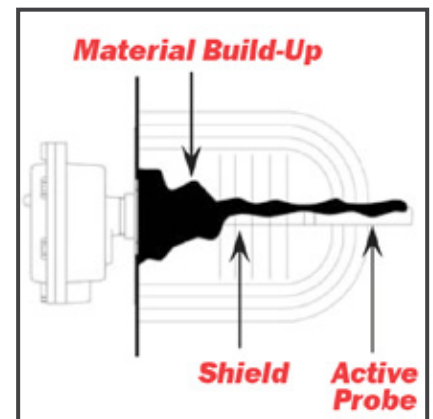

BINMASTER Capacitance Probe PRO-Shield Ignores Material Build-Up

For more technical information and custom options, request our complete catalog on BINMASTER Capacitance Probes.

VIBRATING RODS

With a unique single-rod probe design and a sword-shaped blade that prevents bridging of material, Vibrating Rods are superior to typical “tuning fork” designs by allowing material to easily flow by, preventing build-up on the blade. BINMASTER’s standard 7" piezoelectric-driven vibration-type point level switch is suitable for both top and side mount applications, while rigid extended models can be custom built up to 13' of either galvanized or stainless steel, dependent on the application. Vibrating Rods are suitable for a wide variety of dry and bulk powder materials including extremely light, fluffy materials.



VR-21 STANDARD 7" VIBRATING RODS

BINMASTER **VR-21 Standard 7" Vibrating Rods** are the standard piezoelectric-driven vibration-type point level switches, which have an insertion length of 7.37". They feature three sensitivity adjustments — high for light and fluffy materials, medium, and low, for heavier materials or materials that tend to cling to the vibrating rod. They are easy to install, mounting to the vessel via a standard 1-1/2" NPT mounting socket, and require no calibration. Other features include a self-cleaning sensor, switch selectable high / low fail-safe, and an auto-sensing power supply which can accommodate 20-250 volts AC/DC. Remote electronics via a Point Level Alarm Panel are available to alert to bin levels for 4 to 24 individual sensors.



FEATURES

- Unique “Blade” Probe Design Reduces False Alarms Caused by Build-Up
- No Calibration Required
- Wear and Maintenance Free
- No Moving Parts
- Three (3) Sensitivity Adjustments
- Universal Power Supply
- Self-Cleaning Sensor
- Remote Electronics Available
- Switch Selectable High / Low Fail-Safe

APPLICATIONS: Carbon Black, Plastics, Fly Ash, Feed, Seed, Grain, Food, Chemicals, and other materials with low dielectric constants and densities 1.25 lbs / ft³ or greater.

VR-41 RIGID & VR-51 FLEXIBLE EXTENDED VIBRATING RODS

BINMASTER **VR-41 Rigid & VR-51 Flexible Extended Vibrating Rods** are intended for top mount locations. The VR-41 Rigid Extended Vibrating Rod is available in lengths from 13" up to 13', and the VR-51 Extended Vibrating Rod is available in lengths from 19" up to 19'. A rigid 1" pipe extension is available in galvanized steel, dependent on the material application. The VR-41 and VR-51 Vibrating Rods are custom-manufactured at BINMASTER’s factory to meet customer specifications.



FEATURES

- Insertion Length from 13" to 13' (VR-41) or 19" to 19' (VR-51)
- Unique “Blade” Probe Design Reduces False Alarms Caused by Build-Up
- No Calibration Required
- Wear and Maintenance Free
- No Moving Parts
- Three (3) Sensitivity Adjustments
- Universal Power Supply
- Self-Cleaning Sensor
- Remote Electronics Available
- Switch Selectable High / Low Fail-Safe

APPLICATIONS: Carbon Black, Plastics, Fly Ash, Feed, Seed, Grain, Food, Chemicals, and other materials with low dielectric constants and densities 1.25 lbs / ft³ or greater.

CVR-600 MINI VIBRATING RODS

BINMASTER **CVR-600 Mini Vibrating Rods** are compact vibrating rods that are ideal for small bins, hoppers, and feeders. Featuring an overall insertion length of just 6", they are suitable for space-constrained applications. They can be mounted on the top or side of the bin for high, medium, and low level indications. They are easy-to-install, fitting through a standard 1" NPT mounting socket, and can be used in process temperatures up to 300°F.



FEATURES

- Compact Single Rod Design
- No Calibration Required
- Wear and Maintenance Free
- No Moving Parts
- High / Low Level Fail-Safe
- Three (3) Sensitivity Adjustments
- Universal Power Supply
- Self-Cleaning Sensor
- 1" NPT Mounting
- 6" Insertion Length
- Remote Electronics Available
- Process Temperatures up to 300°F
- Screw-Top Enclosure

APPLICATIONS: Plastics, Food, Seed, Chemicals, and material densities 3.5 lbs / ft³ or greater.



SHT-120/140 HI-TEMP VIBRATING RODS

BINMASTER **SHT-120/140 Hi-Temp Vibrating Rods** are designed specifically for higher process temperatures — up to 482°F. They feature a standard insulation tube that insulates the electronics from excessive heat, and have a standard insertion length of 7.25" for both top and side mount applications. They can be extended from 13" to 13' using a rigid pipe extension when extra length is desired.

FEATURES

- Single Stainless Steel Design
- Lagged Design to Locate Electronics Away from Heat Source
- No Calibration Required
- No Moving Parts
- High / Low Level Fail-Safe
- Wear and Maintenance Free
- Three (3) Sensitivity Adjustments
- Universal Power Supply
- Self-Cleaning Sensor
- 1-1/2" NPT Mounting
- Remote Electronics Available
- Insertion Length from 7.25" to 13'

APPLICATIONS: Plastics, Food, Seed, Chemicals, extremely light and fluffy materials with low dielectric constants, and material densities less than 1.25 lbs / ft³.



TILT SWITCHES

Tilt Switches are versatile, cost-effective level indicators that can be used to alert personnel to high levels and clogged chutes, or used as a load sensor in a wide variety of applications and materials. Activating an alert when the device tilts at least 15°, it is used to detect high levels of large, heavy materials in bins, tanks, and silos. Alternatively, it can be used to detect plugs or clogs in chutes during process operations. The Tilt Switch features a simple, mechanical design that allows it to also be used as a high-limit sensor when positioned over open piles or conveyor belts.

TILT SWITCH

BINMASTER **Tilt Switches** feature a rugged design that offers reliable operation with only one moving part. When tilted at least 15°, a steel ball inside of the device shifts position and activates a microswitch, alerting the user to a high level or clogged status. Generally, an optional stainless steel paddle extension or plastic sphere is installed on the end of the device to increase the sensitivity of the tilt switch. The tilt switch is installed over a desired control point using a wire rope, chain, or other flexible hanger capable of supporting the device.

FEATURES

- Economical High Level Point Detection
- Rugged Construction and Easy Installation
- Simple Design with One Moving Part
- Switch Activated at 15°
- Stainless Steel Paddle or Plastic Sphere Options Available

APPLICATIONS: Grain, Sand, Gravel, Concrete, Aggregates, Coal, applications where conventional devices cannot be mounted, and other material densities of 15 lbs / ft³ or greater.

Stainless Steel Tilt Switch Shaft with plastic sphere is also available for light powders and bulk solids under 30 lbs / ft³.



“Affordable High Level & Clogged Chute Detection”

POINT LEVEL ALARM PANEL

The BINMASTER **Point Level Alarm Panel** is designed to alert the user to vessel level conditions via a blinking LED light and audible alarm, saving time and eliminating the need to manually inspect vessel levels. Level indicators are placed strategically at desired points in each vessel, enabling the user to be automatically notified when a bin reaches a full, partially full, or empty level. The Alarm Panel can also be connected to an external horn or common alarm to provide alert status from a variety of locations throughout a facility. Consolidating information at a convenient, centralized location, the Point Level Alarm Panel is available with 4 to 24 vessel level indicator stations, making it capable of monitoring high and low status for 2 to 12 separate vessels from a single panel.

FEATURES

- Available with 4, 8, 12, 16, 20, or 24 Stations
- NEMA 4X Enclosure
- Front Panel LED Alarm and Power Indication
- Indicates a Level Point with Eye-Catching Signal Light and Audible Alarm
- Modules on Alarm Panel can be Connected to External Common Alarm (Horn)

APPLICATIONS: Operates with a variety of point level indicators.



For more technical information and custom options, request our complete catalog on BINMASTER Tilt Switches & Point Level Alarm Panels.

PRESSURE/DIAPHRAGM SWITCHES

Pressure/Diaphragm Switches provide simple, low-cost, automatic level indication of free flowing dry materials such as grain, feed, seed, and other granular or pelleted materials. They operate by sensing material pressing against the diaphragm, and activating a visual or audible alarm to start or stop a process or alert personnel to high, medium, or low levels in bins. BINMASTER offers models for hazardous and non-hazardous environments, internal or external mounting, and either neoprene or silicone diaphragm covers.

BM45 STANDARD DIAPHRAGM SWITCH

BINMASTER **BM45 Standard Diaphragm Switches** are pressure switches that provide simple, low cost, point level control with proven, lasting reliability. The BM45 Series is offered in six different models. The variations include standard, heavy-duty neoprene, or heavy-duty silicone diaphragm material, and either internal or external mounting options. The basic, yet reliable, operating mechanism is very rugged and requires minimal maintenance. It can be used in conjunction with BINMASTER's Point Level Alarm Panel, which is a console used to alert the user to bin level conditions for 4 to 24 level indicator stations. It helps save time by allowing the user to monitor high, medium, and low-levels of multiple bins from a single console.

FEATURES

- Rugged Construction and Simple Design
- Very Economical Point Level Detection
- Neoprene or Silicone Diaphragm Material
- Internal or External Mount
- Multiple Voltages

APPLICATIONS: Feed, Seed, Grain, Food, Rubber, Plastics, Light Powders, Granulars, some plugged chute applications, and material densities 20 lbs / ft³ or greater.

Diaphragm Switches are the most common devices used for high level detection.



“Reliable Bin Overflow Protection”

BM65 HAZARDOUS LOCATION DIAPHRAGM SWITCH

BINMASTER **BM65 Hazardous Location Diaphragm Switches** offer UL Class II, Groups E, F & G explosion-proof certification and can be used in environments where there is a risk of combustible dust. The BM65 offers both internal and external mounting options — with the external mount offering simple installation and easy access to the operating mechanism. To make it adaptable to a variety of materials, BINMASTER offers the choice of a standard neoprene, a heavy-duty neoprene, or a heavy-duty silicone diaphragm.

FEATURES

- HAZLOC Approval Class II
- Rugged Construction and Simple Design
- Very Economical Point Level Detection
- Neoprene or Silicone Diaphragm Material
- Internal or External Mount
- Multiple Voltages

APPLICATIONS: Feed, Seed, Grain, Food, Rubber, Plastics, Light Powders, Granulars, some plugged chute applications, and material densities 20 lbs / ft³ or greater.

Diaphragm Switches are the most common devices used for high level detection.

For more technical information and custom options, request our complete catalog on BINMASTER Diaphragm Switches.

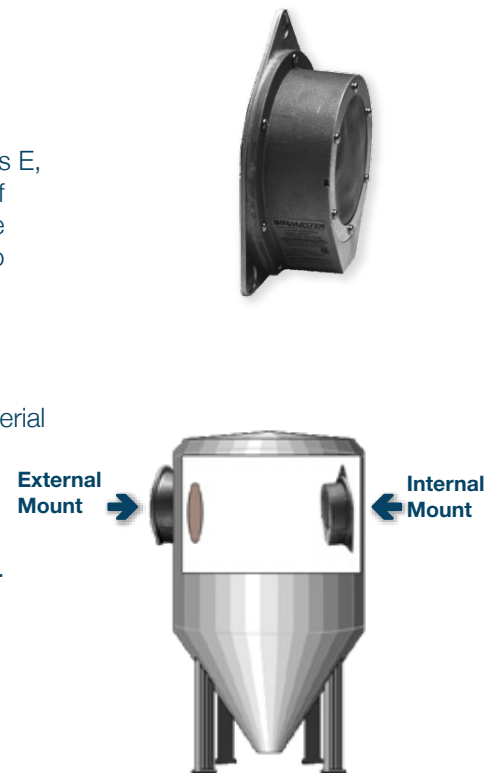



Swiveling Stainless Steel Flange Option

NO CONTACT RADAR DETECTION

NCR-80 LEVEL SENSOR

The BinMaster **NCR-80 LEVEL SENSOR** is a non-contact radar level sensor designed specifically for superior performance in powders and bulk solids. Its advanced technology uses an 80 GHz frequency focused in a narrow 4° beam angle.

This ensures reliable performance at measuring ranges up to 393 feet and accuracy within 0.2 inches. The NCR-80 is ideal for continuous level measurement in tall and narrow vessels where there is excessive noise or dust. Reliable level measurement. 80 GHz of power.

NON-CONTACT RADAR WITH SUPERIOR PERFORMANCE IN SOLIDS

There are two configurations of the NCR-80 and three different housing options including plastic, stainless steel, or aluminum. One configuration features a 10° swiveling, stainless steel flange for precise targeting at the material in the silo. It is suitable for high temperature applications up to 392°F. The other configuration mounts using an 8° swiveling flange or a mounting strap that allows for adjustable targeting and has a lightweight plastic antenna. The plastic antenna is for use in process temperatures up to 176°F.



Lightweight Plastic Antenna Option

FEATURES

- Powerful 80 GHz non-contact radar
- Measuring distance up to 393'
- 4° beam angle for precise targeting
- Reliable accuracy within 0.2 inches
- High temperatures up to 392°F
- Hazardous location approvals
- BinDisc option simplifies setup and configuration

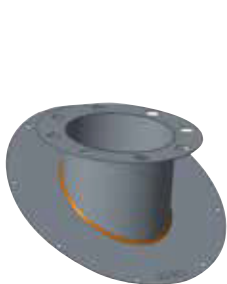

30° Mounting Plate



30° Mounting Plate with NCR-80 metal jacketed model



0° Mounting Plate



0° Mounting Plate with NCR-80 metal jacketed model



The **Narrow 4° Beam Angle** allows for precise aiming to avoid the flow stream, internal structure, or sidewall buildup. Narrow focusing also simplifies setup, as the signal will reflect only from the measured material being targeted. The NCR-80 is resistant to interference, while its advanced filters ensure rapid signal processing and a fast update rate. Its advanced firmware constantly tracks echoes and automatically eliminates false echoes for reliable performance.

SEALED SYSTEM IS MAINTENANCE FREE

The antenna lens is encased in a sealed antenna system. This makes it resistant to dust buildup and virtually maintenance free. The NCR-80 has a flush face that does not protrude into the vessel which prevents potential damage to the sensor. The plastic lens is made of durable, PEEK plastic for ruggedness and long lasting performance. It is chemical resistant for tough applications and has FDA approval, making it suitable for food and pharmaceutical use.

The NCR-80 comes standard with an air purge connection, which is only necessary for extreme conditions with high dust that will cause dust buildup on the lens. It is designed for low air consumption to save on compressed air costs, ensuring fast and efficient cleaning for high dust applications.

80 GHz focuses a narrow 4° beam that measures only material; a 10° beam from 26 GHz may detect internal structure, corrugation, or buildup.

FAST AND SIMPLE SETUP WITH BINDISC

An optional BinDisc interface enables push-button sensor setup and configuration. The BinDisc is integrated into the sensor housing and is installed and visible under the housing cover for easy viewing.

BinDisc simplifies setup and provides continuous, at-a-glance, operational status of the sensor. This handy interface aids in on-site system diagnosis. Data can also be sent to a PLC in a control system.

SMARTBOB INVENTORY MANAGEMENT

SmartBob Inventory Management Systems are designed for continuous inventory level management. The SmartBob Sensors are installed at the top of a vessel, and when prompted to take a measurement, the rugged motor releases a nylon cable from the supply pulley and a weighted sensor probe descends to the surface of the material. When the sensor probe touches the material surface, measurement information is transmitted. These versatile measuring devices can be used in conjunction with eBob Inventory Management Software, the SmartBob Control Console, the BINMASTER Remote Start Unit (RSU), and the MUCM Communication Module.

SMARTBOB2 CABLE-BASED SENSOR

BINMASTER **SmartBob2 Cable-Based Sensors** are the core components of a proven, reliable level measurement system using cable-based sensing technology. The SmartBob2 can be uniquely configured using a variety of probe designs and extensions for solid, slurry, and liquid applications. Long-lasting, hassle-free service is ensured by SmartBob's unsurpassed cable cleaning system. The SmartBob2 is extremely rugged, featuring the industry's strongest cable and motor design, which is completely sealed in a strong, lightweight, molded polycarbonate enclosure which is explosion proof and rated for Class II, Groups E, F, & G Certifications. Requiring no field calibration, SmartBob2 is easy to install, requires minimal wiring, and can even be used with the SmartBob Wireless Transceiver.

FEATURES

- Economical, Regardless of Number of Units Installed
- 5th Generation eBob PC-Based Inventory Management Software
- Output & Display Consoles for 1 to 120 Bins
- No Field Calibration or Adjustment
- Advanced Microprocessor-Based System with Built-In Measurement Reliability
- Minimal Ongoing Operational & Maintenance Cost
- RS-485 Network w/Wiring Distance up to 4,000 ft
- Simple Daisy-Chain Wiring Allows Easy Installation
- Built-In Wireless Options Available

APPLICATIONS: Plastics, Chemicals, Coal, Concrete, Food Ingredients, Pharmaceuticals, Feed and Grain, Aggregates, and Other Powder & Bulk Solids Materials



SMARTBOB TS1 CABLE-BASED SENSOR

BINMASTER **SmartBob TS1 Cable-Based Sensors** are economical and compact inventory management systems that are installed at the top of the vessel. Its compact, yet rugged design, weighs less than 10-lbs and is immune to airborne dust and filling noise that can interfere with other continuous level devices. It can be mounted on angled or flat roofs and can be used in vessels up to 40' tall. The SmartBob TS1 is compatible with eBob software and consoles from BINMASTER's SmartBob Inventory Tracking System.

FEATURES

- Economical, Regardless of Number of Units Installed
- 5th Generation eBob PC-Based Inventory Management Software
- Output & Display Consoles for 1- to 120-Bins
- No Field Calibration or Adjustment
- Advanced Microprocessor-Based System with Built-In Measurement Reliability
- Minimal Ongoing Operational & Maintenance Cost
- RS-485 Network w/Wiring Distance up to 4,000 ft
- Simple Daisy-Chain Wiring Allows Easy Installation
- Built-In Wireless Options Available

APPLICATIONS: Carbon Black, Plastics, Fly Ash, Feed, Seed, Grain, Food, Chemicals, and Other Materials



SMARTBOB MULTIBOB SYSTEM

The BINMASTER **SmartBob MultiBob System** allows from 2 to 32 SmartBob Sensors to be mounted in a single bin, tank, silo, or any other vessel containing powders or bulk solid materials. The measurement data from each sensor is averaged in the advanced eBob software based on user-defined parameters to provide a single level measurement and percentage full for the bin.

The MultiBob System is useful when installed in any bin where the user wants more data to determine inventory levels. The measurement data, as reported in feet by the SmartBob sensor, is very precise and repeatable. Each sensor measures in the same location every time, detecting level changes in bins containing difficult-to-measure material, such as large diameter bins with areas where material tends to pile up.

In addition to multiple point measurement, the advanced eBob software allows the user to add a strapping table to the bin parameters to further personalize the data for a particular bin. Strapping tables are helpful when the material in the bin tends to compact, which makes the bulk density of the material higher at the bottom of the bin than the top. In a non-linear vessel, the addition of a strapping table will improve the estimated volume of material in the tank.

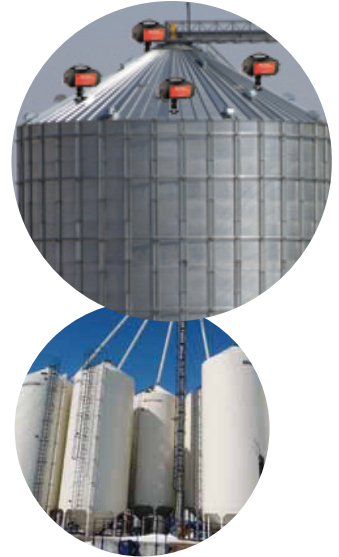

FEATURES

- Two to 32 SmartBob Sensors on a Single Vessel
- Software Averages Level for Selected Sensors
- View Levels for One Sensor or All Sensors
- Can Indicate Cone Up or Down Conditions
- Detects High and Low Spots
- Strapping Tables for Custom Vessel Configuration
- Measurements at User-Defined Levels
- Initiates Measurements on Demand
- Automated Alerts for Various Alarm Conditions
- No Climbing and No Tape Measurers!

APPLICATIONS: Plastics, Food, Seed, Chemicals, and Other Powder & Bulk Solid Materials



The BINMASTER **eBob Inventory Management Software** is designed to help users gather real-time inventory data from storage bins. The eBob program works in conjunction with BINMASTER SmartBob2 Remote Level Sensors to provide measurement data to a personal computer. This bin measurement monitoring solution collects data from up to 100 vessels and allows for data to be viewed via LAN network connections by authorized users. eBob Software generates reports that can be used to increase operational efficiency and provide valuable real-time and historical data used for effective decision making.

EBOB MANAGES CRITICAL INVENTORY DATA SUCH AS:

- Vessel Name, Number, and Content
- Distance to Product (Headroom)
- Product Volume and Weight
- Percentage Full
- Date and Time of Last Measurement
- Measurement Device Status — Descending, Retracted, and Inactive
- Measure Button to Active New Measurement
- Headroom Checkbox to Calculate Remaining Volume
- Strapping Tables for Non-Linear Vessels

SMARTBOB COMMUNICATION ACCESSORIES

REMOTE INITIATION & DETECTION

SmartBob combines technology advances and common sense to give you the strongest and smartest inventory measurement system on the market. Through digital signal processing and advanced electronics, SmartBob2 gives you more communication options than any other system. We've made the best inventory measurement system even better, providing the most cost-effective and easiest-to-implement solution for maximizing your inventory control.

SMARTBOB C-100 CONTROL CONSOLE

The BINMASTER **SmartBob2 Control Console** is the simplest way to remotely initiate and view vessel measurements. This compact, manually-operated console can control from 1 to 128 SmartBob2 sensors with the push of a button. Individual bin heights are programmed into the console and measurements are displayed as distance to product, height of product, and percentage full. The display also indicates the status of the SmartBob during the measurement cycle. Bin heights and percentage full data of the most recent measurements are retained in the C-100 Console's memory, even in instances of power loss. A C-100 MB option allows control of a SmartBob sensor network via Modbus Interface.

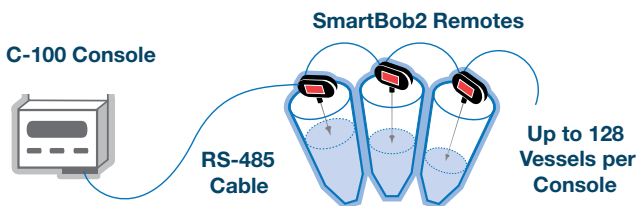

FEATURES

- Back-Lit LCD Graphics Display Accesses Vessel Data Instantly
- Intuitive User Interface Easy to Configure Unit and Retrieve Data
- Six-Button, Membrane Style External Keypad for User Control
- Enter Key, Escape Key, and Four Directional Keys for Ease of Operation
- Menu System of Simple Choices and Value Adjustments

SMARTBOB C-50 ANALOG EXPANSION CONSOLE

The BINMASTER **SmartBob C-50 Analog Expansion Console** interfaces with the C-100 SmartBob Control Console to provide multiple 4-20 mA outputs, enabling monitoring of multiple bins equipped with the SmartBob2 or SmartBob TS-1 Sensors from a single C-100 SmartBob Console. The C-50 Analog Expansion Console connects to the C-100 SmartBob Console via a dedicated RS-485 Cable. Then, the C-100 SmartBob Console is connected via a daisy chained RS-485 network to monitor from 1 to 120 SmartBob sensors.



FEATURES

- Requires Less Equipment to Monitor More Bins
- Accommodates 4-20 mA Outputs from Single Device
- Works with SmartBob2 and SmartBob - TS1 Sensors
- Up to 5 Expansion Consoles Supported on Single Network
- 120 Bin Monitor Allowance
- Polycarbonate, Wall-Mountable Enclosure Offers Good Impact Resistance
- RS-232 Port for Flash Updates and Maintenance
- Meets US and International Requirements for Control of Electromagnetic Interference (EMI) and Electrostatic Discharge (ESD)

For more technical information and custom options, request our complete catalog on BINMASTER SmartBob Communication Accessories.

SMARTBOB REMOTE INITIATION

SMARTBOB REMOTE START UNIT

The BINMASTER **Remote Start Unit (RSU)** provides a variety of enhancements to the SmartBob2 System: an external start input, a 4-20 mA current loop (analog) output, and a remote display or remote readout of the measurements. These enhancements allow for a simple interface between the SmartBob2 Sensor and Programmable Logic Controllers (PLC) or Distributed Controls Systems (DCS). The PLC/DCS can initiate a measurement by providing a dry contact closure to the RSU. The PLC can then retrieve the measurement from the analog 4-20 mA current loop output on the RSU. The remote readout feature allows you to view the current measurement information at each vessel or in a control room away from the controlling PLC or DCS. The display provides distance to product, height of product, percentage of products in vessel, and status of the Bob.

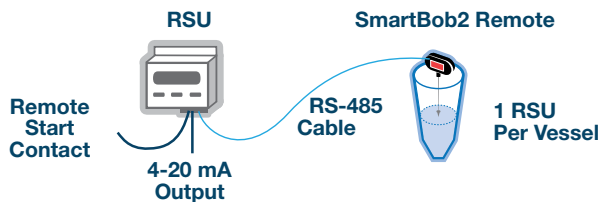

FEATURES

- Simple to Wire and Operate
- Built-In Timer to Allow for Setting of Repetitive Time Intervals to Actuate Measurements
- Easy-to-Read LCD Display
- Provides a Variety of Enhancements When Used in Conjunction with SmartBob Remotes

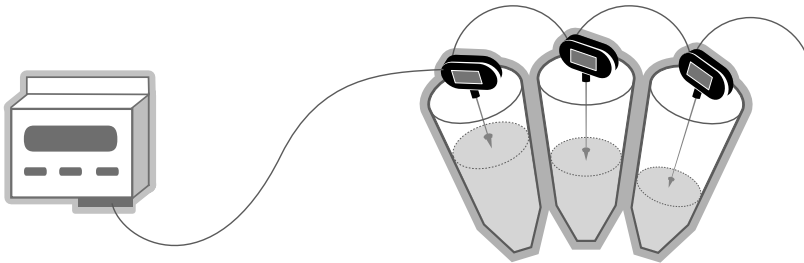

SMARTBOB2 MUCM COMMUNICATION

The BINMASTER **SmartBob2 MUCM Communication Module** enables the operator to tie SmartBob2 remotes into an existing control system when performing communication translations between serial protocols. The MUCM comes with a pre-loaded SmartBob2 application compiled and downloaded into its Flash memory. The standard SmartBob2 MUCM allows a Modbus serial master to gather data from up to 32 SmartBob2 Remotes. The MUCM is easy to program and eliminates the need for analog input and output cards.

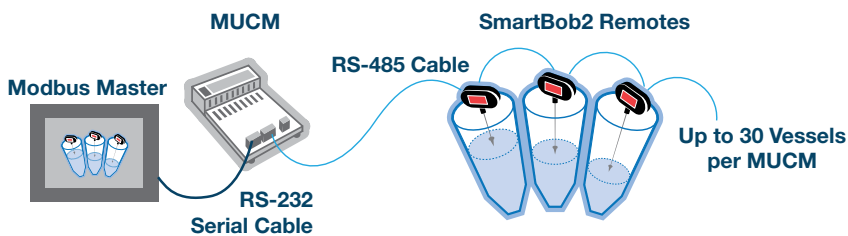

FEATURES

- Proven Technology
- Reliable & Repeatable Measurements
- Not Affected by Changing Material Characteristics
- Minimal Contact with Material
- No Field Calibration or Adjustments Required
- Affordable

For more technical information and options, request our complete catalog on BINMASTER SmartBob Communication Accessories.

DATA TRANSCEIVERS



BINMASTER's **Wireless Data Transceiver** eliminates the need for running long spans of communication cable by providing affordable, two-way wireless data communication between SmartBob II Remotes mounted on top of storage vessels and a control source on the ground. Wireless Data Transceivers can be used in point-to-point network applications, or multi-point network applications.

Not sure which SmartBob Communication Accessories work for your application? Send us the data sheet specifics, or give us a call at 800.332.9770!



SMARTBOB WIRELESS DATA TRANSCEIVERS

The BINMASTER **Wireless Data Transceiver** eliminates the need for running long spans of communication cable by providing affordable, two-way wireless data communication between SmartBob2 Sensors mounted high on top of storage vessels and a control source on the ground. BINMASTER's long-range Wireless Data Transceiver operates in the license-free portion of the FCC designated industrial frequency band at 900 MHz. Designed to work in high interference environments, the Wireless Transceivers combine advanced frequency hopping and digital signal processing technology with outstanding receiver sensitivity and antenna diversity, resulting in exceptional noise and interference rejection and, ultimately, peace of mind. Wireless data networks can be effective in new SmartBob2 installations as an alternative to wired connections. They can also be used to expand the capabilities of existing systems.

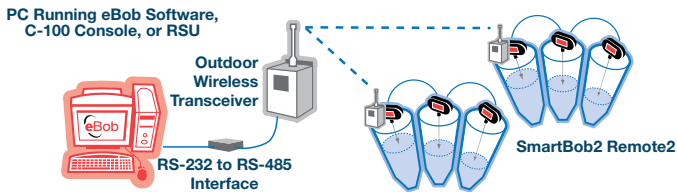

FEATURES

- Save Money by Reducing Installation Costs
- Installation Speed, Flexibility, and Simplicity
- No Leased Lines or Wireless Service Costs
- Single Radio Module for Worldwide License-Free Operation
- Low Latency for Real-Time Applications
- User-Programmable

BINVIEW® WEB-BASED BIN MONITORING

BINMASTER **BinView Web-Based Bin Monitoring** enables remote wireless inventory management of bulk solids or liquids for bins, tanks, and silos. The core components of the solution are the SmartBob2, SmartBob TS1, SmartSonic Ultrasonic, or SmartWave Radar sensors mounted on the bins, a wireless or wired data communications network, a gateway to provide connectivity to a personal computer or IP network, and data collection software that can be accessed by any computer that has a connection to the internet. BinView provides 24/7 real-time control as data streams instantaneously from BINMASTER Sensors to the internet, providing accurate, reliable bin information. Automated alerts immediately send email and cell phone alerts when bin conditions meet user-defined thresholds. BinView eliminates the need to manually check bin levels, which saves time, money, and manpower, and improves the efficiency of ordering and logistics. Advanced reporting includes historical records that help companies maximize inventory management, enhance decision making, understand trends, and keep people informed at every level of the organization.



Remote wireless inventory management of solid material or liquids from your PDA, Cell Phone, or the Internet.



For more technical information and custom options, request our complete catalog on BINMASTER Communication Accessories.

ULTRASONIC & RADAR LEVEL SENSORS

Continuous Non-Contact Measurement

The **SmartSonic Ultrasonic Transmitter** is an ultrasonic device designed for continuous, non-contact level measuring and monitoring of tanks, bins, and silos. Its transmitter features high-efficiency, narrow-beam design technology using a wide frequency bandwidth to enhance operation in difficult applications, varying temperatures, and harsh environments. The SmartWave Pulse Radar Transmitter is a low-noise pulse radar transmitter for distances up to 100'. A display console, compatible with both devices, can be used for remote indication of bin levels for up to five bins.

SMARTSONIC ULTRASONIC TRANSMITTER

The BINMASTER SmartSonic UltraSonic Transmitter is designed for continuous, non-contact level measuring and monitoring of tanks, bins, and silos. Simple, push-button calibration allows for full and empty tank distance to be set in moments. The transmitter range allows for level readings from 0.4 - 90' in liquid applications and 1 - 45' in many powder and bulk solid applications. Its modular design allows a SmartSonic application to be scalable and configurable for a multiple number of transmitters, relays, current loops, PC, and PLC interfaces. Offering various voltage options, the SmartSonic Transmitter can be powered with 12 to 30 VDC or 110/230 VAC. When used with optional RS-232 or RSD-485 connections, a SmartSonic can interface directly to a PC allowing for data collection, parameter changes, and transmitter diagnostics.

FEATURES

- Power Control Operation in Transmitter
- Easy, 2-Point, Push-Button Calibration
- 4-20 mA Signal Output
- RS-485 Communications with PC-Based Utility / Diagnostic Program
- Built-In Temperature Compensation
- Logarithmic Receiver w/Very High Dynamic Range
- Uniform Polar Pattern
- Self-Cleaning Operation

APPLICATIONS: Liquids, Plastics, Grain, Sand, Aggregates — measuring range from 4" - 90'.

SMARTWAVE PULSE RADAR TRANSMITTER

The BINMASTER **SmartWave Pulse Radar Transmitter** is a very accurate, low-noise pulse radar transmitter for distances up to 100'. It is designed to allow for the tracking of any material from the tip of the rod antenna to the bottom of the tank, regardless of the tank shape or environmental conditions. It is highly sensitive and reliable; any build-up on the rod antenna does not deteriorate the performance of the radar probe. Its unique radar design eliminates problems when a target is close to the antenna, while also providing for optimal performance and accurate measurements.

FEATURES

- Low Noise
- Accurate and Reliable
- High Sensitivity
- Self-Adjusting Amplitude and Width of Microwave Pulse
- Easy, 2-Point Push-Button Calibration
- 4-20 mA Signal Output
- RS-485 Communications w/PC-Based Utility / Diagnostic Program
- Uniform Polar Pattern
- No Mounting Influence

APPLICATIONS: Food, Beverages, Water/Wastewater, Chemicals (w/Vapor), Plastics, Sand, Grain, Aggregates, Hot Asphalt — measuring range up to 100' using 6.3 GHz operating frequency.



The SmartSonic Ultrasonic Display can be used with SmartSonic or SmartWave Transmitters for remote indication of bin levels.



The SmartSonic Ultrasonic Display can be used with SmartSonic or SmartWave Transmitters for remote indication of bin levels.



3D LEVEL SCANNER

Non-Contact, Dust Penetrating 3D Technology

BINMASTER's **3DLevelScanner** is a non-contact, dust-penetrating bin volume measurement system that uses patented, acoustic-based technology to measure bin contents at multiple points to determine the volume of material in the bin. Its 3DLevel Manager software sends detailed log reports to a personal computer for easy remote monitoring, with advanced models featuring optional surface mapping capabilities. It offers very low maintenance and is self-cleaning, making it ideal for high-dust environments.

3DLEVELSCANNER

Unlike single point devices, the BINMASTER **3DLevelScanner** works by measuring multiple points within the bin. This advanced acoustics-based technology is proven to perform in powders and bulk solids contained in tanks, silos, warehouses, and even open bins and piles. It is ideal for food processing, pharmaceuticals, or chemicals where contact with the material being measured must be avoided. Its unique 3D mapping capabilities provide a visual representation of bin contents, detecting cone up or down as well as sidewall build-up.

FEATURES

- Multiple-Point Bin Volume Measurement Accounts for Uneven Material Surface
- Measures Virtually Any Powder or Solid Material w/Density of at Least 12 lb/cu ft
- Acoustic-Based, Low Frequency Technology is Unaffected by Dust
- Works Where Ultrasonic and Radar Won't
- Sends Bin Data to Personal Computer Loaded with 3DLevel Manager Software
- Optional Surface Mapping Capability
- Communications via 4-20/HART, Modbus, RTU or TCP/IP
- Easy to Install and Self-Cleaning

APPLICATIONS: Pellets, Granular Powders, Grain, Seed, Feed, Food Processing, Bioenergy Plants, Plastics Manufacturing, Aggregates, Cement, Pulp and Paper, Petrochemicals, Chemical Processing, Coal, Fly Ash, Clinker, and any High Dust Environment

MVL MULTI-SCANNER SYSTEM FOR LARGE BINS

The BINMASTER **MVL Multi-Scanner System** provides greater inventory accuracy in applications with very large bins, tanks, or silos. This multiple scanner system integrates the multiple point measurement data from two 3DLevelScanners to cover a very wide surface area which allows it to provide inventory volume with greater accuracy than previously available from any level measurement device. Using advanced processing and software, the MVL also displays a visual representation of the material surface that shows high and low points in the bin such as cone up, cone down, sidewall build-up, or bridging.

In an MVL System, two scanners are mounted on the top of the vessel in locations optimized to most effectively cover the entire surface area of the material being measured. The scanners take multiple measurements of the material surface using dust-penetrating, acoustic-based technology. A controller combines the data from the two scanners and generates a single merged visual representation of the topography of the material and displays the image on a PC loaded with the 3D Vision Software. The MVL provides diverse data including estimated volume; minimum, maximum, and average distances to material in the bin; as well as a synchronized 4-20 mA output to a PLC or DCS.

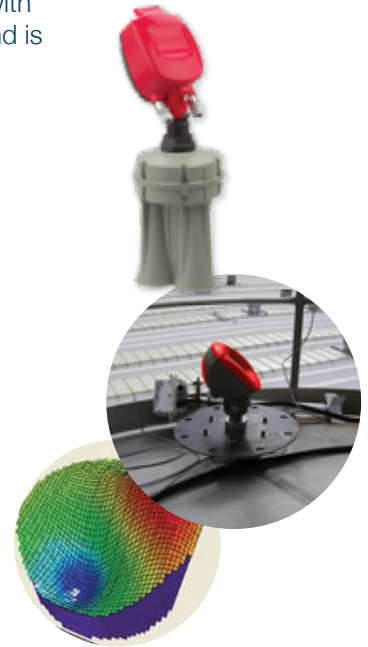

For more technical information and custom options, request our complete catalog on BINMASTER 3DLevelScanner 3DLevelScanner Systems.

GUIDED WAVE RADAR

GWR-2000 Guided Wave Radar for Powders & Solids

BINMASTER'S **GWR-2000** guided microwave level transmitter utilizes time domain reflectometry (TDR) to continuously measure the distance, level, and volume of powders and solids in bins, tanks and silos. The transmitter is mounted on the top of the vessel in an unobstructed area through a 1-1/2" NPT opening or 3" ANSI flange. A single, flexible 8 mm stainless steel cable with a counter weight is suspended from the transmitter to the bottom of the vessel.

Reliable level measurement in high dust and low dielectrics

The transmitter emits a high frequency microwave pulse guided along the cable. When the pulse reaches the material surface, the pulse energy is reflected back up to the sensor head. Level is calculated based on the time difference between the pulse being sent and the reflected pulse received. This sensor features hazardous location approvals, a very small upper dead zone, and assures highly accurate level measurement in low dielectric materials down to 1.3.



GWR-2000 for Bulk Solids

- Measuring distance up to 100'
- For light to heavy bulk solids
- 4-20 mA and Modbus RTU communications
- Performs in high dust
- Immune to condensation
- Virtually maintenance free
- Reliable accuracy within 0.08"
- Hazardous location approvals
- BinDisc simple set up and configuration



DUST DETECTION

Alerts to Changes in Dust Emissions

BINMASTER's single device **Dust Detect 1000** is designed to continuously monitor the flow of particulate emissions from small stacks or other emission points being passed through a filter within an air filtration system. It easily installs in the exhaust ductwork and can be used in conjunction with various types of bag, ceramic, cartridge, or cyclone filters. Its probe is designed to recognize abnormal particulate levels outside user-defined preset parameters, initiating an alarm when changes in emissions exceed these levels.

DUST DETECT 1000

The BINMASTER **Dust Detect 1000** utilizes triboelectric technology, whereby the collision and interaction of particles with the probe rod causes a small electrical charge transfer to occur. This small electrical charge provides a signal that is monitored by the electronics. It is designed to prevent false readings, even if an accumulation of dust forms on the sensor rod. Emissions readings are averaged, not smoothed, to eliminate false alarms. It can be set to make pre-warning indicator alerts to potentially hazardous situations, or be set to provide an instantaneous alarm or one-minute averaged readings.

FEATURES

- Complies with US and International EPA Regulations
- Emissions Readings are Averaged, Not Smoothed, to Eliminate False Alarms
- Pre-Warning Indicator Alerts to Potentially Hazardous Situations
- Easy Set-Up
- Two (2) SPDT Relay Outputs

APPLICATIONS: Metals, Chemicals, Fly Ash, Plastics, Pharmaceuticals, Food, Utilities, Mining, Pulp and Paper, and applications which require continuous monitoring of emissions through an air filtration system. Designed for general maintenance planning and process protection applications for baghouses, cartridge filters, bin vents, and cyclones.

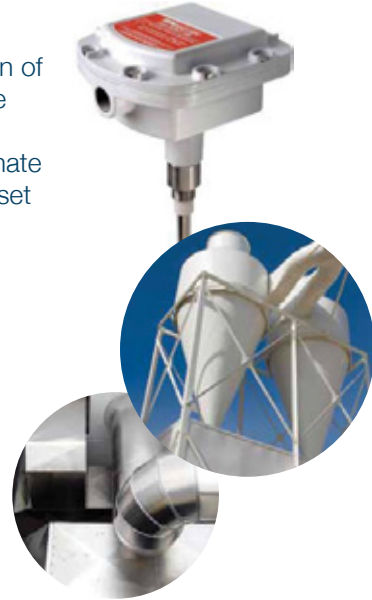

BM-30 LGX PARTICULATE MONITOR

The BINMASTER **BM-30 LGX Particulate Monitor** is designed for general process and environmental monitoring. This system consists of a control unit, a particulate sensor, and a sensor coaxial cable. It detects many types of particulates including solid particulates, such as dusts, powders, granulars, and pellets, as well as liquid particulates, such as mists. Particulate monitoring helps meet regulatory requirements by detecting leaks before emissions are visible, and prevents the escape of valuable powders while providing a cleaner, safer workplace.

FEATURES

- Early Detection of Broken Bags Prevents Cross Contamination of Materials
- Prevents Unforeseen Downtime and Expensive Equipment Repairs
- Simple Plug-and-Play Alarm System
- Dust Coating on Sensor Won't Affect Signal or Trigger False Alarms
- Available in CSA-Approved Intrinsically Safe Version for Hazardous Areas
- Provides Essential Monitoring and Control to Prevent Loss of Valuable Materials

APPLICATIONS: Cement, Foundry, Steel, Chemical, Carbon Black, Grain, Pharmaceutical, Minerals, Powders, Wood, Aluminum, Food Processing, Coal, Incineration, and other materials. Designed for general maintenance planning and process protection applications for baghouses, cartridge filters, bin vents, and cyclones.



For more technical information and custom options, request our complete catalog on BINMASTER Dust Detection Systems.

FLOW / NO-FLOW DETECTION FOR SOLIDS

Appropriate for solids or powders, BINMASTER's **Flow Detection System** alerts users if the flow status has changed, power is lost, or communication is interrupted. This system consists of a remote sensor probe mounted in either a pneumatic pipeline, gravity chute or feeder, and a control console mounted in an area accessible to users. The non-intrusive sensor probe is an industrial grade instrument that senses flow / no-flow conditions using DOPPLER technology (microwave) to provide highly reliable and sensitive motion detection.

FLOW DETECT 1000 DETECTION SYSTEM

The BINMASTER Flow Detect 1000 Detection System consists of two components — the FDS1000 Remote Sensor Probe, which is mounted in a pneumatic pipeline, gravity chute or feeder — and the FDC1000 Control Console, which is mounted in an area accessible for users to read the console during operations. The FDS 1000 Remote Sensor Probe is a high quality, industrial grade instrument that senses flow / no-flow conditions using DOPPLER technology. It works by transmitting a low energy signal through a TEFLON process seal into the material flow stream. A portion of the signal is reflected back to the sensor, with the movement of material causing a frequency shift called the DOPPLER Shift, which is used by the sensor to detect material flow.



FEATURES

- DOPPLER Technology Provides Reliable Motion Detection
- Non-Intrusive Flush Mounting Senses Through Non-Metallic Surfaces
- Non-Contact Operation Eliminates Flow Stream Interruption and Equipment Wear
- Control Settings Made Without Accessing the Remote Sensor Probe
- Fail-Safe Power Protection & Loop Fault Monitor
- "Quick-Set" Selectable, Single-Turn Calibration
- HAZLOC Approval Class II
- Alarm for Flow / No-Flow Status

APPLICATIONS: Food Processing, Plastics, Grain, Cement & Aggregates, Paper, Mining, and other materials. Virtually unaffected by humidity, ambient light, pressure, vacuum, temperature, or noise.



FDS 1000 Remote Sensor Probe

FDS 1000 Control Console



For more technical information and custom options, request our complete catalog on BINMASTER Flow Detection Systems.

THE AIR PAD

AIRBRATOR

The Air Pad with both Aeration and Vibration!

Using a combination of both aeration and vibration, the Airbrators helps solve some of the most difficult material flow applications. Its special design creates a vibration as the air flows between the Airbrator pad's boot and the bin wall. Appropriate for use in any type of bin or silo, the airbrator is extremely economical, quite easy to install, offers durable construction and is self-cleaning.



“SOLVES MATERIAL FLOW PROBLEMS IN BINS AND SILOS”

The Airbrator is a very effective flow aid for many types of dry materials such as flyash, cement, flour, lime, sands and salt – as well as many other difficult granular or powder bulk solid materials – and can even be used with abrasive materials. Airbrator features a stainless steel shaft and can be used in food-grade applications. As an added benefit, Airbrator pads do not require a specific air pressure for operation. It can use high or low pressure blower air from as low as 5 PSIG to as high as 60 PSIG.

FEATURES

- Vibratory action promotes material flow
- Can be used in any type of silo or bin
- Affordable and economical
- Stainless steel shaft
- Easy to install
- Self-cleaning
- Built-in check valve
- Durable construction
- Rated up to 400° F
- Uses low or high pressure air
- Suitable for abrasive materials
- For granular or powdered materials
- Appropriate for food grade applications

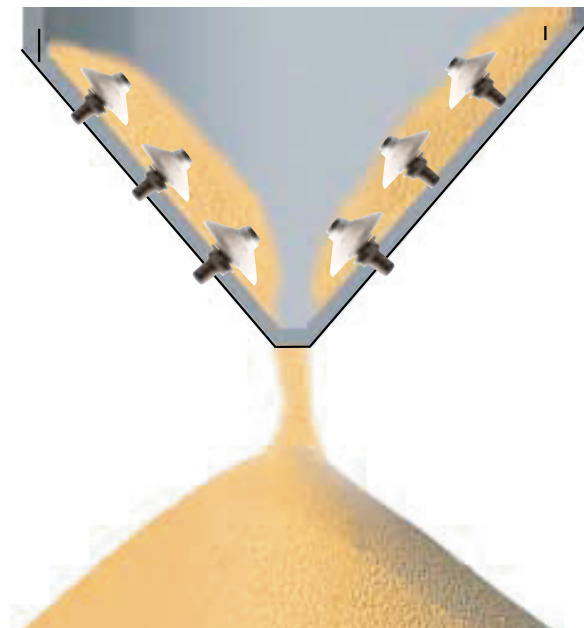

The **Airbrator** airpad is designed to help dry granular and powdered bulk material that tends to hang up or bridge to consistently flow from silos and bins. Multiple Airbrators can be installed as strategic locations inside the lower cone of the bin along areas where material tends to stick or bridge. By combining both aeration and vibration, the Airbrator can resolve some of the more difficult material flow applications that aeration alone cannot.

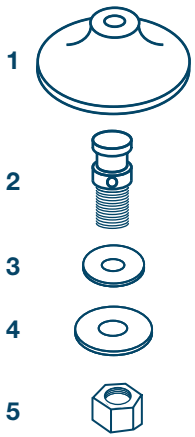

PARTS DESCRIPTION

1. White Silicone rated at 400° F or Neoprene Pad rated at 250° F12345
2. 303 SS Stud
3. White Sealing Washer
4. 7/8" Flat Washer
5. 7/8"-14 UNF Hex Nut

The special design creates a vibration as the air flows between the Airbrator's boot and the bin wall. This provides a very effective flow aid for all types of dry products. Plus, Airbrator pads do not require a specific air pressure for operation. Blower air from as low as 5 PSIG to high pressure air up to 60 PSIG can be used with the Airbrator.

Solves flow problems with many applications and materials!

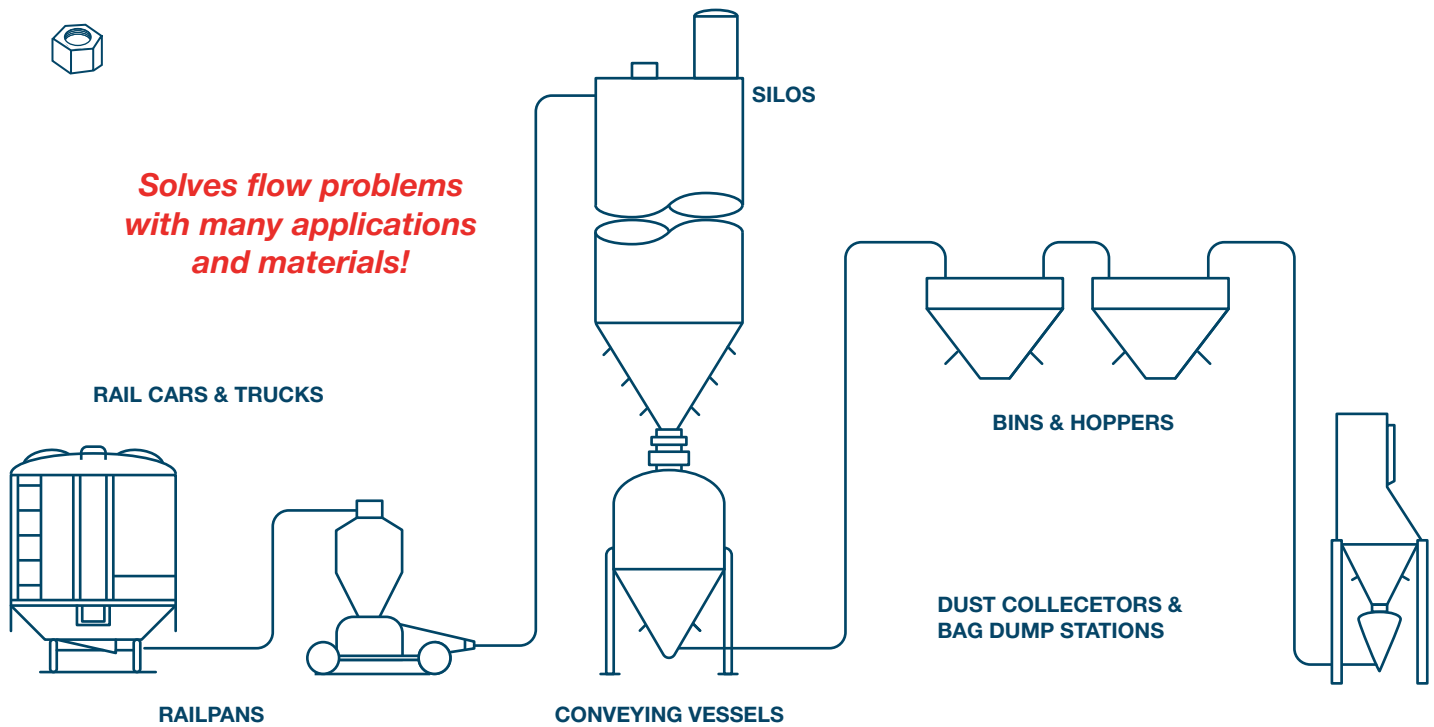

Suitable for Granular or Powdered Materials

Applications: Alumina, Ash, Bag House Dust, Barite, Bentonite, Carbon Black, Flyash, Flour, Fluorspar, Gypsum, Lime, Perlite, Cement, Clay, Calcium Carbonate, Cornstarch, Cement Clinker, Diatomaceous Earth, PVC Resin, Salt, Sand, Soda Ash, Soap Powder, Talc



AIRMATIC INC founded in 1944, is a woman-owned Industrial Distributor, with installation and maintenance capabilities, offering equipment, machinery, and shop supplies to the Industrial, Construction, Utility, Government, and Commercial Markets. Our products and services are sold through three business units:

The **MATERIALS MANAGEMENT GROUP** provides products and services to industries that convey, store, transport, and process powders and bulk solids from aggregates, cement, and chemicals to foods, grains, metals, power generation, and waste water treatment applications;

The **SERVICE GROUP** provides fabrication, installation, and maintenance services to improve bulk materials handling efficiency; mechanical clean-out services for silos and hoppers to eliminate material flow problems; and shop repair/rebuilding and modifications services of products sold by the Company.

The **TOOL GROUP** provides power tools, personal protective equipment, materials-handling equipment, shop equipment and MRO supplies used for production, fabrication, assembly, metal removal, maintenance, and storage in manufacturing, construction, utility, and commercial applications. Our Customers tell us that by choosing **AIRMATIC** to solve their problems, they gain increased productivity, decreased costs, and a safer, cleaner work environment.



Established in 1953, **BINMASTER** is an ISO-certified company that designs and manufactures reliable, solid-state, point and continuous bin level indicators and inventory control systems, and sensing and monitoring devices used when conveying, storing or processing powder and bulk solids such as cement and aggregates, chemicals, feed and grain, food, plastics, biofuels, pharmaceuticals, pulp and paper, and wood products.

AIRMATIC

284 Three Tun Rd. Malvern, PA 19355

215.333.5600

infocenter@airmatic.com

airmatic.com